

CalMag Heating Pack Installation Instructions



Heating Filter



Corrosion Inhibitor



Scale Inhibitor
(if applicable)



Cleanser

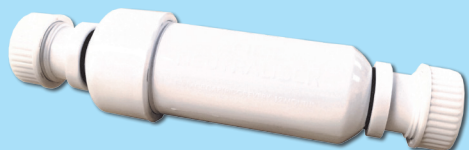

Acidic Neutraliser

CalMag HF2 Filter Installation Instructions

CALMAG HF2 FILTER 22mm

Why fit a CalMag filter? Radiator panels provide the largest surface area of a central heating system where they act as heat emitters. They are usually made of mild steel, which is highly reactive to corrosion. Even with a quality corrosion inhibitor installed, low levels of corrosion can occur. In the absence of air this is usually black magnetite, which is magnetic in nature and which can therefore be captured with a magnet. Although magnetite is seven times heavier than water and quite happy to sit in the bottom of the radiator from whence it came, some particles are dispersed around the system by the flow. If a magnetic filter does not collect these particles, they will surely end up trapped in the next device with electro-magnetic properties; the circulator pump where they will cause premature wear. The magnetic filter can also double as a sampling point to analyse the system water, or become the treatment point for liquid chemical additives. The table below shows some water conditions and suggested remedial action that can be determined from visual inspection of the contents of the filter canister:-

Water Condition	Suggested Remedial Action
Clear water, no magnetite	System appears to be corrosion free - inspect annually. Top up inhibitor every one to three years
Clear water, magnetite build up	System is corroding. Clean filter, add inhibitor, inspect every one to three months
Black water, magnetite build up	System is corroding badly. Clean the system - consider Power Flushing, then add inhibitor on final fill
Orange water, no magnetite	System is corroding due to ingress of air - investigate mechanical fault then clean the system then add inhibitor on final fill
Orange water, magnetite build up	System is corroding due to ingress of air and likely absence of inhibitor. Investigate mechanical fault. Clean the system - consider Power Flushing, then add inhibitor on final fill

Please retain these instructions for future use.

Do's:

- Install the filter upright to enable it to be fully removed of air during commissioning. The inlet and outlet can also be swapped to suit.
- Where the filter is fitted to the metallic heating system, earth bonding continuity is required around it. All bonding connections must be accessible and labelled "Safety Electrical Connection - Do Not Remove".
- Service the filter annually (at boiler inspection) to remove any collected debris.
- Use the filter in conjunction with a scale and corrosion inhibitor ie. CM1-500.
- The inlet/outlet valves have PTFE valve seats, which can be initially stiff. Operate with the hex end of the service spanner.



- When using the key/cap to bleed air from the system make sure you have a bucket handy to catch the spill. Screw key/cap onto drain valve as a drip cover.

Don'ts:

- Magnets may affect or interfere with sensitive mechanical and electronic instruments such as heart pacemakers, computers / magnetic media and watches. Always keep magnets at least 300mm away from such equipment.
- NEVER close the INLET or OUTLET isolation valves, OR UNDO the lid when the pump is running!
- Don't get scalded! Allow the system to cool before operating the device.
- Don't fit the device too close to the boiler - allow at least 300mm gap and sufficient space to service the unit.
- Don't tighten the lid with the service spanner - over tightening could damage the unit.

CalMag HF2 Filter

Installation Instructions

Installation Instructions

Only a competent person such as a qualified heating engineer should install the device.

1. Locate a suitable site for the filter to allow access and servicing. We recommend that you fit it on the return. Do not fit it between the boiler and the overflow on open vented systems.
2. Release heating system pressure and drain the pipe-run where the filter is to be located. It may be necessary to drain the whole system.
3. **Vertical pipe runs:** measure and mark a 152mm section and remove the marked section with a rotary tube cutter.

ISOLATING VALVES SHOULD BE ACCESSIBLE IN ORDER TO ISOLATE THE UNIT



HEATING FILTER MANIFOLD

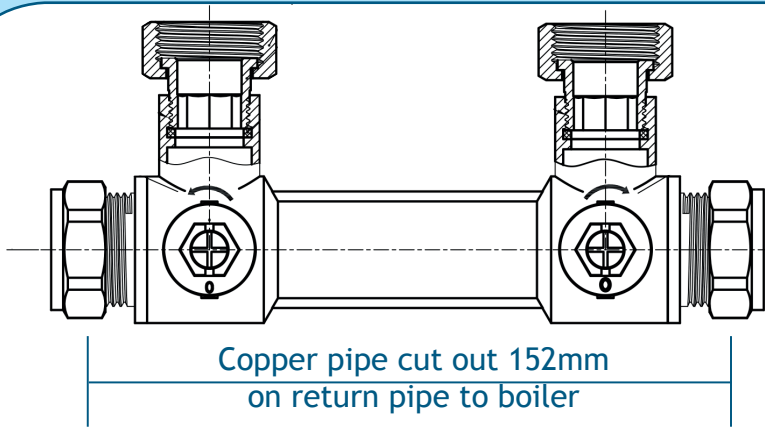

4. Fit the manifold into cut out, and tighten the compression fittings.
5. Loosely secure the canister to the manifold ensuring the canister is upright and square. Don't fit the washers at this point as you are pre-assembling the filter to assess it for fit. Providing everything lines up proceed to the next step, otherwise make any necessary adjustments.
6. Loosen off the valve flange nuts and insert the washers. Thoroughly tighten the flange nuts, taking care not to over tighten. Ensure washers are used.
Tighten the lid only by hand, making sure the 'O' ring is still in position.
7. Refill the heating system, ensuring the inlet and outlet valves are both in the OPEN position, with the drain valve in the CLOSED position and the bleed screw on top of the unit open, when water is seen coming from the bleed valve close the screw.
8. Start the heating system. Bleed the filter again after the system has reached the necessary temperature. Take care when doing so as the water expelled will be hot. Observe the unit, checking that there are no leaks.
9. The unit has now been successfully commissioned. If fitted correctly it will be silent in operation. We suggest its serviced annually to remove any particulate matter that has been collected. This should be carried out at the same time the boiler is serviced.

Chemicals

Cleanser Installation Instructions

How to add to systems

Connect Powerflushing equipment to system. Leaving all radiators open, add 500ml of cleanser per 10 radiators. To test that the mix has reached all parts of the system, switch the boiler on and see if the radiators are heating up evenly. We recommend circulating the mixture around the system for 30 minutes to 1 hour for an average heating system. Allow more time for heavily sludged systems. Cleanser can be left in the system for up to 2 weeks without any detrimental effects.

Cleanser should be used prior to the corrosion inhibitor.

Other chemicals may need to be required to remove contaminants ie, sludge & flux remover, descaler etc.

We strongly recommend that the boiler be serviced annually along with adding a further bottle of corrosion inhibitor to maintain long term protection of the central heating system.

It is also strongly advised that as part of the boiler servicing the CalDensate cartridge be replaced and that the heating filter is thoroughly cleaned to maintain system efficiency.

Chemicals

Inhibitor Installation Instructions

How to add to systems

There are different ways to add the inhibitor to a system with the easiest being through a header tank, or a non pressurised system.

The second way is through a radiator, pressurised or non pressurised systems.

This can usually be determined for a pressurised system if the boiler has a pressure gauge attached to it. If so, then this usually indicates that it is a pressurised system.

Header Tank

1. Turn off boiler.
2. Locate drain tap at the bottom of a radiator. Attach a hose to the drain tap, ready to run to drain. Do not open the drain tap at this point. Please note a hose clip may be required to fasten to the hose tap to prevent spillage.
3. Locate the header tank and turn off the make up supply. The header tank is normally located in the roof space, or loft. If unsure as to which is the cold water tank and which is the header tank then it would be beneficial to run the hot and cold taps in a bathroom until the cold water tank's make up runs.
4. Open the drain at the bottom of the radiator and drain off water. When the header tank has fully drained, close the drain tap.
5. Turn the make up back on and add the chemical at the correct dosage rate into the system whilst refilling the header tank. Dosage rate should be at 10% of the total system make up - on a system with 10-15 radiators, 500ml should be sufficient.
6. Wait for the header tank to completely fill.
7. Disconnect the hose from the drain tap and check for any leaks.
8. Avoid spillage by taking precautionary measures when used.

Pressurised System

1. Turn off the boiler and make a note of the operating pressure.
2. Locate a drain tap at the bottom of a radiator. Choose the lowest point within the heating system to ensure that all the system will be treated.
3. Attach a hose to the drain tap, ready to run to drain. Open the drain tap. Please note a hose clip may be required to fasten to the hose tap to prevent spillage.
4. Locate a radiator at the top of the heating system and open the air vent. Air should now rush in. Continue draining the system until the chosen radiator has drained approximately 30% (3-4ltr). Turn off the drain and remove the hose.
5. Unscrew the air vent plug at the top of the radiator.
6. The inhibitor can now be added into the system using an adaptor to fit the air vent plug or bleed valve and squirted directly into the system at the correct dosage - on a system with 10-15 radiators, 1 litre should be sufficient.
7. Screw the air vent plug back into the radiator. Ensure that PTFE is used for the air vent plug thread.
8. Refill the system to the operating pressure noted at the outset and vent the radiators to remove any air from the system.
9. Venting may also be required in two to three days after the initial vent and avoid spillage by taking precautionary measures when used. Ensure that any excess fluid is wiped off all surfaces and fittings.

Heating Filter

See **Annual Service Requirements** section for the installation instructions.

CalDensate

Installation Instructions

CalDensate:

- A condensing boiler is a high efficiency modern boiler, incorporating an extra heat exchanger, so that hot exhaust gases lose much of their energy to pre-heat the water in the boiler system.
- When working at peak efficiency, the water vapour produced in the combustion process condenses back into liquid form, releasing the latent heat of vaporisation.
- The water, known as condensate, is produced as a side-effect and is usually acidic, containing dissolved oxides of sulphur and nitrogen, and has to be piped away to drain.
- There are a number of problems which occur when acidic water enters the water system, and simply installing the CalDensate will ensure that the pH is neutralised by means of the specially formulated media which is included in the product.
- This easy to fit in-line unit is a by-product of our own successful commercial products. The CalDensate is effective, economical and environmentally friendly due to the fact that the throw away cartridge is biodegradable and the housing never needs replacing and therefore does not harm the environment in terms of waste in landfill sites - this is the only product on the market place with these unique features.

Points to consider:-

1. Limited free play in rigid pipework.
2. Ensure that the unit is compact when the pipework has been cut.
3. The condensate is usually discharged periodically in "slugs" by siphonic action.
4. Is suitable for use with all types of condensate discharge overflow pipes.
5. Always consult the boiler manufacturer's installation instructions.
6. Fit in accordance with BS6798.

CalDensate Installation:

1. Turn off the water supply if necessary.
2. Turn off the boiler.
3. The CalDensate should be installed either vertically or alternatively with a slight incline away from the boiler to ensure that the acidic waste falls away naturally with gravity.
4. Ensure that the installation takes into consideration the need to replace the internal cartridge on an annual basis.
5. The CalDensate does not have the need for directional flow and can be installed simply and easily in any direction.
6. Unscrew the cap fitting and slide the gasket and cap onto the boiler condensate discharge pipe.
7. Push the unit onto the boiler condensate discharge pipe until it hits the stop inside the unit.
8. Slide the cap and gasket to the unit and firmly screw the cap back onto the unit body. Ensure the angle of the gasket sits neatly into the angle of the body fitting. This only needs to be hand tight - do not use excessive force.
9. Unscrew the bottom cap fitting and gasket and slide both onto a suitable length of condensate discharge pipe.
10. Push the condensate discharge pipe to the unit until it hits the stop inside the unit.
11. Slide the cap and gasket to the unit and firmly screw the cap back onto the unit body. Ensure the angle of the gasket sits neatly into the angle of the body fitting. This only needs to be hand tight - do not use excessive force.

Typical installation:

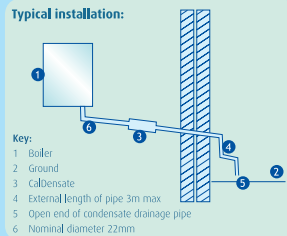

12. Continue and complete the installation of condensate pipe in accordance to BS6798 (typical installation shown below).

13. Turn on the water supply if necessary.

14. Turn on the boiler. Check for leaks.

- To maintain the performance of the CalDensate, it is strongly recommended to replace the cartridge in line with the annual service of the condensing boiler.
- If the unit is installed externally, adequate protection from frost, water and extreme weather conditions must be considered and dealt with accordingly. In situations where the external condensate drainage pipe is less than a nominal diameter of 32mm, the pipe must be protected from frost and also be insulated against potential water.

Scale Inhibitor Installation Instructions

For hard water areas (if applicable).

1 Turn off water supply.



2 Drain relevant pipework or system where the CalMag unit is to be installed.

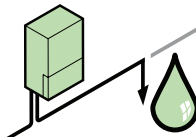

3 Allow time for system to cool down if fitted in line.

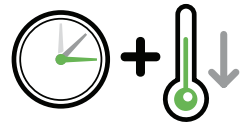

4 Cut pipe to suit length of unit. The unit should be installed a minimum of 1 metre from an appliance or on the incoming mains after the stop cock.

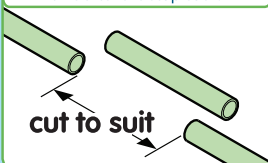

5 Push the unit into place, ensuring that the fittings are pushed fully into position. Tighten the compression fittings to make a seal. Do not overtighten.

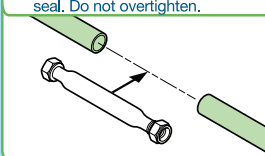

6 Re-open the system slowly. Check for leaks.



Annual Service Requirement

Heating Filter:

1. Before commencing any service work, turn off the boiler and isolate the electrical supply. Wait for the temperature to cool before undertaking any work to avoid scalding. Turn both isolating valves to the OFF position. Have a bucket ready to collect spillage and OPEN the drain valve to release internal pressure. CLOSE the drain valve again to free your hand.
2. Open the lid by turning anticlockwise using the service spanner. Remove by lifting upwards to withdraw the magnet and plastic sleeve.
3. Withdraw the plastic magnet sleeve. Some debris may stick to the non-magnetic sleeve but the remaining debris will fall to the bottom of the canister.
4. Have a bucket ready to collect spillage and reopen the drain valve to allow the debris to escape. Rinse out the canister with fresh water and clean the bowl, lid, O-ring and magnet before reassembling.
5. Tighten the lid retaining-ring only by hand. Ensure the inlet and outlet valves are both in the OPEN position, with the drain valve in the CLOSED position. Refill the system to recommended pressure and bleed the unit using the bleed screw on top.
6. Bleed the filter again after the system has reached the correct temperature. Take care when doing so as the water expelled will be hot. Observe the unit, checking that there are no leaks.

Chemical Dosing:

- At step 4 in servicing, carefully pour a bottle of water treatment corrosion and scale inhibitor (sufficient capacity is available to hold 500ml) into the canister. Replace lid with plastic sleeve covering the magnet. Use CalProtector or CM100.
- Continue with step 5 in servicing.
- Allow the system to circulate for 5 minutes to disperse the chemical treatment.
- Continue with step 6 in servicing to complete the operation.

Densate R:

1. Turn off the water supply if necessary.
2. Turn off the boiler.
3. Remove the CalDensate unit from the pipework.
4. Remove cap and replace cartridge.
5. Dispose of old cartridge.
6. Re-install CalDensate.
7. Turn on water supply if necessary.
8. Turn on the boiler. Check for leaks.

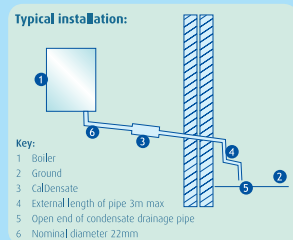

- To maintain the performance of the CalDensate, it is strongly recommended to replace the cartridge in line with the annual service of the condensing boiler.
- If the unit is installed externally, adequate protection from frost, water and extreme weather conditions must be considered and dealt with accordingly. In situations where the external condensate drainage pipe is less than a nominal diameter of 32mm, the pipe must be protected from frost and also be insulated against potential water.

Warranty:

The limited warranty is subject to the following terms and conditions:

- I. That the products have been correctly installed and serviced in accordance with the instructions herein provided. The warranty does not cover damage or defects caused as a result of improper installation or servicing.
- II. That the products have not been tampered with or misused.
- III. That the products have not been modified in any way.
- IV. That the product labels have not been removed.
- V. That the products have been returned at the purchaser's own cost together with proof of purchase in the form of an original receipt or invoice (which will be returned).
- VI. The sole and exclusive remedy under this warranty is for the repair or replacement of the products and no other remedy including but not limited to incidental or consequential damage or loss, irrespective of nature shall be available.
- VII. This warranty will not cover any associated installation costs incurred as a result of the products being defective.
- VIII. Our decision on matters relating to warranty claims shall be final.

This warranty does not affect your statutory rights. Full terms and conditions are available on request.

Notes:

Please refer to the current Building Regulations, British Standards and manufacturer's boiler instructions at all times.

Phone: 01535 210320

Fax: 01535 210321

Email: sales@calmagltd.com

Web: www.calmagltd.com



Calmag Ltd
Riverview Buildings, Bradford Road,
Riddlesden, Keighley, West Yorkshire, BD20 5JH