

Polypipe Plumbing & Heating



Installation Guide

Contents

03 Introduction

Plumbing & Heating Pipes & Fittings

05 Fittings
06 Plumbing & heating pipe
07 Pipe stiffeners

PolyPlumb

09 Jointing and dismantling



PolyMax

13 Jointing and demounting

PolyFit

15 Jointing and demounting
16 Flexible Hoses

PolySure

19 Jointing

System Installation

22 Introduction
22 Service conditions
23 Application information
25 Connections to other materials
28 Installation of pipework in floors and voids
31 Pipe and fitting blanking

Plumbing & Heating System Testing

33 Introduction

Underfloor Heating

35 Introduction
36 Guide to typical applications
38 Selecting the right pipe
38 Metal Composite Pipe installation
40 Underfloor Heating usage pipe table

Solid Floor Systems

42 Introduction
45 Panel system
48 Clip Rail system
50 Staple system



Floating Floor Systems

54 Introduction
56 Installation instructions

Suspended Floor Systems

62 Introduction
64 Double Heat Spreader Plates
66 Overlay™ Lite 15 - Suspended floor application
68 Fit from below - Double Heat Spreader Plates
70 Batten systems (DHSP only)
72 Modular Heating Panels

Existing Floors & Low Profile Systems

76 Introduction
80 Overlay™ Plus
82 Overlay™
84 Overlay™ Lite 15

Underfloor Heating

90 Guide to floor coverings for Underfloor Heating systems

Manifolds, Testing, Filling & Commissioning

92 Introduction
93 Stainless Steel Manifold
97 Polymer Manifold
100 Brass Manifold



Room Temperature Controls

106 Introduction
108 Smart Plus Controls
114 Smart Controls
126 Traditional Controls

Single Room Applications

135 Introduction
136 Wiring details

System Performance Tables

139 Heat output tables
141 Fault finding charts

Standards & Approvals

143 Standards and Polypipe guarantee information

Further Technical Information

145 Technical support

Plumbing & Heating Installation Guide

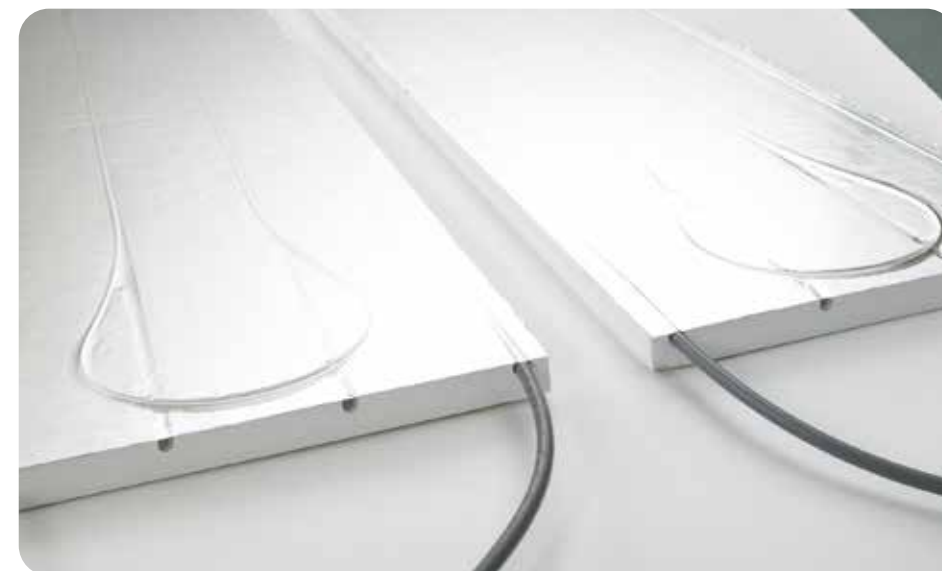

Welcome to the new Polypipe Plumbing & Heating Installation Guide. This installation guide combines all of our plumbing and heating related products into one single catalogue of product information.

Alongside all of our best known product ranges, you will also find several exciting new additions, continuing our reputation for product innovation and great value. Together they mean Polypipe has the most comprehensive range of plumbing and heating systems available for a single UK manufacturer.

This publication is provided as a comprehensive guide on how to install Polypipe Plumbing and Heating Systems. It is an important document as we cannot accept any liability, or honour any guarantee, for products and systems that have not been installed in accordance with our published instructions.

From time to time our installation advice may be updated at which time previous printed copies will become out of date. The latest version of our installation advice, including a downloadable version of the current Plumbing & Heating Installation Guide, can be found at:

www.polypipe.com/literature-search

Plumbing & Heating Pipes & Fittings



Each range is available in a wide selection of fitting types, plus valves, connectors, brassware and accessories. Use with the appropriate pipe from our comprehensive range of piping systems.

Polypipe recognises that no two jobs are the same and has developed an application-based range of plumbing solutions with four fittings ranges, backed by a range of pipe options.

PolyPlumb

Traditional push-fit plumbing

Original robust, grey system, suitable for a range of applications

PolyFit

Quickfix push-fit plumbing

Hand demountable, ideal for first fix applications

PolyMax

Streamline push-fit plumbing

Slim and sleek, ideal for surface mounted applications

PolySure

Permanent press-fit plumbing

Slim profile fittings, ideal when security is paramount

Polypipe Fitting Solutions

		Size (mm)				Pipe Colour		Joining Method	
		10	15	22	28	Grey	White	Push-fit	Press-fit
Fitting Solutions	PolyPlumb	✓	✓	✓	✓	✓		✓	
	PolyMax	✓	✓	✓	✓		✓	✓	
	PolyFit	✓	✓	✓	✓		✓	✓	
	PolySure	✓	✓	✓	✓	✓	✓		✓

NOTE:

Grey pipe and white fittings can be used together and vice versa, however, please note the 'K' insertion depth mark on the pipe will not be correct, therefore the insertion depth should be measured and marked on the pipe.

Plumbing and heating pipe

At the heart of the Polypipe Plumbing and Heating Systems product range is our commitment to polybutylene pipe.

We choose polybutylene to create the most flexible and efficient pipes and jointing systems available. Polybutylene pipe is ideal for both domestic hot and cold water plumbing and heating systems, offering exceptional durability and long-term performance, which has seen it become the preferred material choice for today's building projects.

The most important characteristic of polybutylene is its natural flexibility, allowing you to bend the pipe into even the tightest of spaces. Polybutylene is the most malleable plastic used in the manufacture of piping systems.

Another key advantage of polybutylene pipe is that it is extremely light in weight, particularly when compared with copper piping systems. For example, 15mm copper tube will weigh approximately 0.28kg/m, compared to just 0.074kg/m for polybutylene. This significant weight reduction is invaluable when transporting materials to site.

Polybutylene pipe has good resistance to freezing temperatures, maintaining long-term durability in heating and water applications.

This, combined with the pipe's elasticity, means that if water is subjected to freezing temperatures, a burst pipe is less likely.

Our plumbing systems also give improved performance over rigid pipe systems in terms of low noise transmission and low water hammer effect.

Underfloor Heating pipe systems

We have supplemented our pipe offers with two ranges of underfloor specific pipe. Our ultra flexible underfloor heating pipe aids installation and handleability whilst our formable MCP pipes provide alternative for installers familiar with this pipe characteristic.

PIPE AND RANGE APPLICATIONS				
Pipe	Flexible Plumbing & Heating Pipe GREY	Flexible Plumbing & Heating Pipe WHITE	MCP Underfloor Heating Pipe WHITE	Ultra Flexible Underfloor Heating Pipe GREY
Fitting Systems	PolyPlumb, PolySure, UFH	PolyFit, PolyMax, PolySure, UFH	UFH	UFH
10mm	Plumbing/ Heating	Plumbing/ Heating		
12mm				UFH
15mm	Plumbing/ Heating & UFH	Plumbing/ Heating & UFH		UFH
16mm			UFH	
18mm				UFH
22mm	Plumbing/ Heating	Plumbing/ Heating		
28mm	Plumbing/ Heating	Plumbing/ Heating		



Pipe stiffeners

All our push-fit plumbing fittings ranges, PolyPlumb, PolyFit and PolyMax, require a pipe stiffener to be inserted into our plastic pipe prior to jointing.

We offer 3 different types of pipe stiffeners dependant on fitting type or installer preference:

Plastic pipe stiffeners can be used with all push-fit ranges – PolyPlumb, PolyFit and PolyMax.

Stainless steel pipe stiffeners can also be used with all push-fit ranges – PolyPlumb, PolyFit and PolyMax.

Sealed pipe stiffeners, which provide enhanced sealing can be used with PolyFit and PolyMax only.



Plastic Pipe Stiffener



Stainless Steel Pipe Stiffener



Sealed Pipe Stiffener

NOTE:

When using sealed pipe stiffeners with PolyFit or PolyMax fittings, the stiffener will normally be retained in the fitting when the pipe is demounted.

Pipe can be remounted over the stiffener whilst in this position. Should the stiffener need to be retrieved the fitting can be disassembled in order to do this.

Sealed stiffeners

The Polypipe sealed pipe stiffeners have been designed to provide enhanced sealing and can be used with PolyFit and PolyMax fittings.

The sealed stiffener incorporates two rubber 'O' rings to give additional security; the seals are positioned at the head of the stiffener and on the outside of the spigot to seal on the pipe bore.

Polypipe sealed stiffeners are supplied pre-lubricated. If any further lubrication is required only Polypipe silicone lubricant should be used. Substances such as solder flux must not be used.

To aid the insertion of the sealed stiffener into the pipe, the pipe should be internally chamfered. The chamfer provides an internal lead on the pipe so the square edge of the pipe does not damage the 'O' ring seal.

Polypipe offer specific chamfering tools for this purpose. The chamfering tools are available as either individual tools or as a block of four, dependent on installer preference.



When using PolyPlumb, PolyFit or PolyMax fittings with copper pipe, pipe stiffeners are not required.

When using our plastic pipe with compression type fittings, only plastic and stainless steel pipe stiffeners can be used.

The pipe stiffener function is provided within the body of the PolySure fitting and is therefore integral – stiffeners are consequently not required.



Traditional push-fit plumbing

PolyPlumb is our original, tried and tested, grey plumbing system. Robust and reliable, PolyPlumb has stood the test of time.

PolyPlumb fittings feature a one step jointing process and a high performance stainless steel grab ring within the fitting, ensuring superb joint integrity.

Use PolyPlumb with Polypipe grey polybutylene flexible pipe, or you can combine PolyPlumb fittings and copper pipe. We recommend the use of a Polypipe metal or plastic pipe stiffener when used with plastic pipe.

PolyPlumb is suitable for use in most plumbing and heating installations, including hot and cold water and underfloor heating applications.

The system offers a number of benefits:

- Our original grey plumbing system, using tried and tested technology for many years
- PolyPlumb provides a superb combination of fast fitting with a permanent, reliable fix
- PolyPlumb offers a one-step jointing process, with joint integrity assured by a high performance stainless steel grab ring
- Demountable by disassembly only
- Use for most hot and cold water supply or heating applications, including underfloor heating
- Use with Polypipe grey polybutylene pipe systems or copper pipe
- Use Polypipe metal or plastic pipe stiffeners

Jointing

There are **five** vital steps to successfully jointing the PolyPlumb system.

Step 1a: Cutting PolyPlumb pipe

Check the pipe is not scored or scratched in any way and if it is, cut back to a point where there is no damage. Using a Polypipe pipe cutter, cut the pipe squarely using the "K" marks on the pipe as a guide. These marks indicate when the pipe has been inserted into the fitting correctly.



Step 1b: Cutting copper pipe for insertion in a PolyPlumb fitting

Wherever possible, use a rotational pipe cutter when cutting copper pipe. Ensure that all cut ends have a rounded lead in, with burrs removed. Never use a hacksaw. You will need to mark the insertion depth on the pipe as below.

Pipe Diameter (mm)	10	15	22	28
Insertion Depth (mm)	22	27	30	35

Step 2: Use of pipe stiffener

Insert a pipe stiffener into the pipe (not required on copper pipe). Pipe stiffeners are an integral part of the joint when using Polypipe grey pipe with either PolyPlumb fittings or compression fittings and need to be fully inserted into the pipe end.

Polypipe offer two types of pipe stiffener to be used with PolyPlumb fittings - metal and plastic. When using a pipe stiffener, ensure it is fully inserted before applying the fitting.



Step 3: Visually check fitting and fitting components

Visually check that all components are present, undamaged and free from contamination.

Lubricants

All Polypipe fittings are supplied with pre-lubricated EPDM 'O' rings. If any further lubrication is required only Polypipe silicone lubricant should be used. Substances such as solder flux must not be used.

Step 4: Insert pipe fully into fitting

Insert pipe into the fitting, ensuring it is inserted to the full socket depth denoted by the next "K" mark on the pipe.



Step 5: Check joint security

A quick tug on the pipe will confirm that the pipe is inserted past the grab ring and that a grab ring was present in the fitting. It does not however ensure that the pipe is fully inserted as this can only be confirmed by using the depth insertion mark.

IMPORTANT NOTE: Do not re-joint

On no account should a pipe be removed from a jointed PolyPlumb fitting by dismantling. If the same fitting is then re-jointed, there is real risk that the outer edge of the grab ring will have become damaged and this will reduce the pull-out performance of the joint when subjected to pressure. The joint will almost certainly fail prematurely and potentially cause serious injury.

Dismantling a PolyPlumb joint

PolyPlumb fittings must not be dismantled for any reason prior to jointing.

Step 1: Procedure for using the component pack of spares. Dismantling the joint

If it is necessary to remove a joint pipe from a fitting, the cap-nut should be unscrewed and the pipe with all the socket components present on the pipe end should be pulled out of the socket of the fitting. The pipe end complete with all the socket components should be cut off and discarded. A complete component pack of socket spares should be fitted to the socket as described below and pipe jointing should be carried out as described.

Step 2: Replacement components

The component pack (Code: PB95XX) is supplied as a cap-nut with all the socket components present in the correct order and retained by a retaining cap.

Step 3: Preparing components

Completely remove the retaining cap, ensuring that the socket components remain within the cap-nut.

Step 4: Replacing the components

Without removing any of the socket components from the cap-nut, introduce the cap-nut and socket components to the socket of the fitting and tighten up the cap-nut by hand, ensuring that the components enter the socket without snagging.

Step 5: Checking the fitting

Carry out a visual check to ensure that all socket components are present in the correct order as shown in the diagram and that the rubber 'O' ring is lubricated. If in doubt, the 'O' ring should be re-lubricated using PolyPlumb silicone lubricant.

Step 6: Fitting the joint

Carry out pipe jointing as described previously.

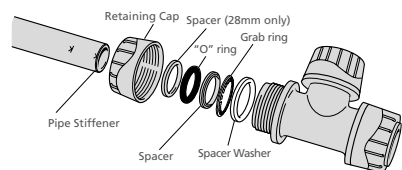

PolyPlumb fittings general arrangement

Reduced component fittings

Changes have been made to 15mm PolyPlumb couplers, elbows and tees and 22mm PolyPlumb elbows, tees and couplers (or connectors), which need to be considered when using PolyPlumb spares kits with these fittings, as follows:

Step 1: Original PolyPlumb fittings

If the bottom white washer is present in the fitting below the grab-ring, then the spares kit can be used as supplied without making any changes.

Step 2: New PolyPlumb fittings

If there is no bottom white washer present below the grab ring with one of the five listed fittings, then this is one of the fittings which has been modified.

Before the spares kit is used, the carrier moulding should be carefully removed from the cap-nut and the bottom white washer should be removed and discarded without changing the order of any of the other components. After this has been done, the spares kit should be offered up to the socket of the fitting, inserting the components into the socket in the order they are within the kit and then screwing down the cap-nut onto the outside of the socket.

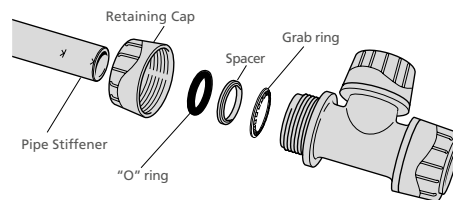

15mm couplers, elbows and tees and 22mm elbows, tees and couplers (or connectors)





Streamline push-fit plumbing

PolyMax is our newest plumbing fitting range, introduced after extensive research, to meet consumer and installer demand.

PolyMax fittings are slim, sleek and attractive, making PolyMax the perfect choice for surface mounted installations. PolyMax is easily demounted using our handy release tool. Use PolyMax with Polypipe white polybutylene flexible pipe, using a Polypipe metal or plastic pipe stiffener. For extra security, choose the new Polypipe sealed stiffener.

PolyMax can be used on a wide range of home improvement and refit projects, including hot and cold water systems.

The system offers a number of benefits:

- New white push-fit system, ideal for home improvement and refit projects
- PolyMax fittings are slim, sleek and attractive: ideal for surface mounted applications
- PolyMax is secure in use but tool demountable
- Use for most hot and cold water supply or heating applications
- Use with Polypipe white polybutylene pipe systems or with copper pipe
- Use Polypipe metal, plastic or sealed stiffeners (15mm and 22mm only)

Joining

There are **five** vital steps to successfully joining the PolyMax system.

Step 1a: Cutting Polypipe pipe

Check the pipe is not scored or scratched in any way and if it is, cut back to a point where there is no damage. Using a Polypipe pipe cutter, cut the pipe squarely using the "K" marks on the pipe as a guide. These marks indicate when the pipe has been inserted into the fitting correctly.



Step 1b: Cutting copper pipe for insertion in a PolyMax fitting

Wherever possible, use a rotational pipe cutter when cutting copper pipe. Ensure that all cut ends have a rounded lead in, with burrs removed. Never use a hacksaw. You will need to mark the insertion depth on the pipe as below.

Pipe Diameter (mm)	10	15	22	28
Insertion Depth (mm)	22	35	42	44

Step 2: Use of pipe stiffener

Insert a pipe stiffener into the pipe (not required with copper pipe). Polypipe offer three types of stiffeners for use with PolyMax fittings: metal, plastic and for extra security - a sealed stiffener (15mm and 22mm only). When using a sealed stiffener, the stiffener will be retained in the fitting when demounted.



Step 3: Visually check fitting and fitting components

Visually check that all components are present, undamaged and free from contamination.

Lubricants

All Polypipe fittings are supplied with pre-lubricated EPDM 'O' rings. If any further lubrication is required, only Polypipe silicone lubricant should be used. Substances such as solder flux must not be used.

Step 4: Insert pipe fully into fitting

Insert pipe into the fitting, ensuring it is inserted to the full socket depth denoted by the next "K" mark on the pipe.



Step 5: Check joint security

A quick tug on the pipe will confirm that the pipe is inserted past the grab ring and that a grab ring was present in the fitting. It does not however, ensure that the pipe is fully inserted as this can only be confirmed by using the depth insertion mark.

Demounting a PolyMax joint

PolyMax fittings are fully demountable and re-usable. To demount a PolyMax fitting use the raised edge of the demounting tool (FITAID) and depress the collet squarely towards the fitting and pull the pipe out of the fitting. Care should be taken that the collet is pushed all the way back to the fitting squarely to avoid scratching or scoring the pipe when it is pulled from the fitting.





Quickfix push-fit plumbing

PolyFit is our hand demountable white, push-fit plumbing system, offering maximum flexibility and adjustability.

PolyFit features a one step jointing operation for quick and easy installation. PolyFit leads the market in speed to fit. If you need to adjust a fitting joint during the installation process, PolyFit fittings can be quickly demounted by hand, or by using our release tool.

Use PolyFit with Polypipe white polybutylene flexible pipe, using a Polypipe metal or plastic pipe stiffener. For extra security, choose the new Polypipe sealed stiffener. PolyFit can be used on a wide range of contract and retrofit projects, including hot and cold water systems, and is particularly suitable for first fix installations.

The system offers a number of benefits:

- One step operation for quick and easy installation
- PolyFit is ideal for first fix applications or when demountability is important
- PolyFit is hand or tool demountable for maximum flexibility
- Use for most hot and cold water supply or heating applications
- Use with Polypipe white polybutylene pipe systems or with copper pipe
- Use Polypipe metal, plastic and sealed stiffeners (15mm and 22mm only)

Jointing

There are **five** vital steps to successfully jointing the PolyFit system.

Step 1a: Cutting Polypipe pipe

Check the pipe is not scored or scratched in any way and if it is, cut back to a point where there is no damage. Using a Polypipe pipe cutter, cut the pipe squarely using the "K" marks on the pipe as a guide. These marks indicate when the pipe has been inserted into the fitting correctly.



Step 1b: Cutting copper pipe for insertion in a PolyFit fitting

Wherever possible, use a rotational pipe cutter when cutting copper pipe. Ensure that all cut ends have a rounded lead in, with burrs removed. Never use a hacksaw. You will need to mark the insertion depth on the pipe as below.

Pipe Diameter (mm)	10	15	22	28
Insertion Depth (mm)	25	35	42	44

Step 2: Use of pipe stiffener

Insert a pipe stiffener into the pipe (not required with copper pipe). Polypipe offer three types of stiffeners for use with PolyFit fittings: metal, plastic and for extra security - a sealed stiffener (15mm and 22mm only). When using a sealed stiffener, the stiffener will be retained in the fitting when demounted.



Step 3: Visually check fitting and fitting components

Visually check that all components are present, undamaged and free from contamination. PolyFit fittings contain; a blue bottom washer; an EPDM 'O' ring; a blue top washer and a collet all held in

place by a cap nut. All cap-nuts are torqued to ensure they cannot unscrew easily. There is no need to undo cap-nuts and remove any components prior to jointing PolyFit fittings.

Lubricants

All Polypipe fittings are supplied with pre-lubricated EPDM 'O' rings. If any further lubrication is required only Polypipe silicone lubricant should be used. Substances such as solder flux must not be used.

Step 4: Insert pipe fully into fitting

Insert pipe into the fitting, ensuring it is inserted to the full socket depth denoted by the next "K" mark on the pipe.



Step 5: Check joint security

A quick tug on the pipe will confirm that the pipe is inserted past the grab ring and that a grab ring was present in the fitting. It does not however ensure that the pipe is fully inserted as this can only be confirmed by using the depth insertion mark.

Demounting a PolyFit joint

PolyFit fittings are fully demountable and re-usable. To demount a PolyFit fitting simply depress the collet squarely towards the fitting and pull the pipe out of the fitting. Care should be taken that the collet is pushed all the way back to the fitting squarely to avoid scratching or scoring the pipe when it is pulled from the fitting. When systems have been pressurised the collet is designed to grip into the pipe therefore using a fitting release aid (Product Code: FITAID) will assist in demounting fittings.



Select your Flexible Hoses

Flexible hoses are a great addition to the PolyFit product range. This versatile collection comes in a wide range of length and connection end combinations to suit every need.

Many of our flexible hoses include the PolyFit one step joint feature and are quick and easy to install - ideal for use in tricky to reach or tight locations.

- All PolyFit flexible hoses are listed under the Water Regulations Advisory Scheme
- Look out for the black thread that is wound into each hose, which denotes a WRAS quality product. Each EPDM hose is suitable for use in domestic hot and cold water applications
- All PolyFit flexible hoses which have a tap connector nut now contain captive rubber seals ensuring that seals are not lost or damaged on-site
- PolyFit flexible hoses come in a packaging design which aids quick and easy product selection and all hoses come in pairs

1 PolyFit Fitting 15mm and 22mm

PolyFit push-fit connections. PolyFit ends are secure in use but also fully demountable and re-usable.

2 Tap Connection Nut 1/2" and 3/4"

These 'wing nut' style tap connector nuts will only require hand tightening.

3 PolyFit Chrome Plated Valve 15mm and 22mm

Our compression end connectors use the same high quality components as the rest of the PolyFit push-fit range.

4 Compression Fitting 15mm and 22mm

Connectors incorporating service valves to reduce the number of joints within a system. Incorporates the PolyFit push-fit feature.





Permanent press-fit plumbing

PolySure is our radial press-fit system, available in UK sizes, and installed using specialist crimping tools.

PolySure features secure, tamperproof jointing technology for a permanent fit.

The slim profile fittings are ideal for use in visible installations. An inbuilt location washer ensures the crimping tool jaws are correctly positioned for accurate fitting and a visual socket depth indicator and double 'O' ring seal provides enhanced jointing.

Use PolySure with Polypipe white or grey polybutylene flexible pipe.

PolySure can be used in any hot and cold water installation but is particularly suited to buildings with high levels of public access traffic, where security and joint integrity are paramount.

The system offers a number of benefits:

- Supplied in both metal and plastic bodied solutions, and offering the same high security
- The first radial press-fit system in standard UK sizes
- PolySure is ideal for applications where security is paramount
- PolySure offers a permanent, tamper proof fit and the slim profile fittings are ideal for visible applications
- Fitted location washer ensures jaws are correctly positioned for crimping
- Visual socket depth indicator and double 'O' ring seal provide enhanced jointing
- Use for most hot and cold water supply or heating applications
- Use with Polypipe white or grey pipe systems

Jointing

There are **seven** steps to completing a joint which uses PolySure fittings. Each step is covered in detail here.

Unlike the other plumbing systems, the PolySure system requires some specialist pressing tools which can be purchased directly from Polypipe or via the manufacturer's stockists. Polypipe recommends using REMS' pressing equipment who have a reputation for manufacturing durable products that can stand up to today's site conditions. For full details of products, instructions, servicing requirements and warranties please visit: www.rems.de

Step 1: Cutting Polypipe pipe

Check the pipe is not scored or scratched in any way and if it is, cut back to a point where there is no damage. Using a Polypipe pipe cutter, cut the pipe squarely using the "K" marks on the pipe as a guide. These marks indicate when the pipe has been inserted into the fitting correctly. It is essential that pipes are cut squarely as this may affect chamfering (see step 2).

The chamfering tools are available in either individual tools or as a block of four dependent on the installers preference, however all work in the same way.

The chamfer tool spigot should be inserted down the bore of the pipe until contact is made with the blades.



The chamfer tool should be twisted gently to provide a lead in. Any debris should be removed from the pipe end and the chamfer tool. Check that the pipe has been cleanly chamfered around the full diameter of the pipe.



Step 2: Chamfering the pipe

As PolySure fittings use press-fit technology which seals on the pipe bore, it is necessary to provide an internal lead on the pipe end so the square edge of the pipe does not damage the 'O' ring seals.

On push-fit fittings this lead in is provided by the pipe stiffener. Polypipe offer specific pipe chamfering tools for our pipes and these must always be used.



If not repeat step 2, if so proceed to step 3.

Step 3: Visually check fitting and fitting components

Visually check that all components are present, undamaged and free from contamination.



Lubricants

All Polypipe fittings are supplied with pre-lubricated EPDM 'O' rings. If any further lubrication is required only Polypipe silicone lubricant should be used. Substances such as solder flux must not be used.

Step 4: Insert pipe into fitting

Polypipe pipes have a visual indicator to assist the installer in jointing pipes and fittings together. The chamfered Polypipe pipe should be inserted into the PolySure fitting and pushed in until pipe can be seen through the hole in the stainless steel pressing sleeve. When this has been done the joint is ready for pressing.



Step 5: Preparing the pressing tools

There are three types of pressing tool recommended for jointing PolySure fittings. The REMS Eco Press is a manual pressing tool which can be used on 10mm, 15mm and 22mm joints only but provides the installer with a lightweight, low cost entry pressing tool which can be used in most situations.

Alternatively the battery operated tools (mini or standard versions) can be used where a high volume of joints needs to be made in a short space of time. The battery operated tools must be used for 28mm fittings.

The 10mm, 15mm and 22mm Polypipe TH pressing jaws have been designed to fit both the manual and standard battery operated pressing tools. The mini pressing jaws are only compatible with mini pressing gun and can not be used with the manual or standard battery operated guns. All jaws are specifically designed to press PolySure press-fit fittings and should only be used for these fittings. Likewise no other pressing jaws should be used for PolySure fittings.

Manual pressing tool

Secure the jaw in the tool by firstly removing the locking pins from the Eco Press, lining up the holes in the Eco Press with those in the jaw and re-inserting the locking pins.



Battery operated pressing tool

To insert a Polypipe TH jaw into the battery operated gun, press the release catch on the locking pin on the gun. Slide the jaw into the gun, aligning the centre hole in the jaw with the locking pin, and push the locking pin back into position until locked. Once the jaws are locked in the respective machine the pressing tools are now ready to complete the joint process.



Step 6: Securing the joint

Whether using the manual or battery operated press gun, the jaws are located onto the fitting in exactly the same manner. Do a final check to ensure that the pipe is still inserted fully into the fitting, then using the white washer as a location point fix the jaws over the fitting in the un-pressed condition.



Manual pressing tool

The levers can now be closed completely, ensuring that the two stops on the press tool are touching.



Extension pieces are included with the Eco Press if extra leverage is required to completely close the tool. Only when the tool has been completely closed with the two stops touching is the fitting fully secured. The levers can then be opened and the fitting will be released from the jaws.

Battery operated pressing tool

The trigger can now be pressed on the tool to start the pressing process. Keep the trigger depressed until the jaws have closed completely and the pressing machine clicks to denote the end of the process.

NOTE: Once the process is underway it must be completed before the safety catch can be pressed to allow the jaws to be released.



Step 7: Checking the joint

Finally, check that the fitting has been pressed successfully by ensuring that the TH pressing profile has been indented consistently around the full circumference of the fitting. The white washer should not be damaged or have moved in any way, if so discard the fitting and re-press a replacement fitting. Spare pressing sleeves and washers are available to purchase if required. Once PolySure fittings have been pressed they are not demountable.



The following information is designed to provide basic guidance for installers when selecting Polypipe products. The information is not exhaustive and guidance may change dependent on site conditions and applications. If in doubt please contact our Technical Services Department on **01709 772200**.

Service conditions

Grey and white plumbing and heating pipe, PolyPlumb, PolyMax, PolyFit and PolySure fittings are suitable for the following Class S service conditions in a normal domestic operation (subject to the exceptions referred to in note 2 below).

(Continuously operated ring main installations are excluded from these applications)



	NOMINAL SYSTEM FLOW TEMPERATURE Tf°C (see note 1 below)	MAXIMUM SYSTEM SERVICE TEMPERATURE Ts°C (see note 1 below)	SYSTEM MALFUNCTION Tm°C (see note 1 below)	SYSTEM MAXIMUM WORKING PRESSURE Bar
Indirect cold water systems	20	20	-	3½
Direct mains-fed cold water systems	20	20	-	12½
Subsurface heating systems (including underfloor)	60	83	100	3½
Vented hot water supply systems	65	83	100	3½
Unvented hot water supply systems including instantaneous heaters and/or incorporating storage	65	95	100	6
Vented central heating systems	82	95	100	3½
Sealed central heating systems	82	105	114	3

Note 1:

- Nominal system flow temperature Tf is the intended maximum flow temperature of a system for a particular application as recommended in codes of practice and other guidance documents
- Maximum system service temperature Ts is the maximum service temperature that can occur intermittently during normal operation
- System malfunction temperature Tm is the maximum temperature likely to be applied to pipes and fitting in the event of control thermostat failure or malfunction

Note 2:

- Certain fittings in the PolyPlumb, PolyMax and PolyFit ranges are not suitable for all the Class S service conditions. The limitations are indicated against every applicable fitting in the Trade Price List e.g. "Cold Water Only"

Application information

Gas, oil and compressed air

Polypipe systems are suitable for domestic plumbing and heating systems. Pipes and fittings must not be used for gas and oil supply pipework or compressed air pipework. In all the above instances metal pipework should be installed.

Continuously operated re-circulating systems (secondary hot water circulation/ring main installations)

A continuously operated re-circulating system is a water-replenished circulating system which is maintained at a constant high temperature to provide a constant source of hot water. Continuously operated re-circulating systems are used to distribute constant hot water to wards or rooms that may be distant from the heat source or hot water storage vessel. Locations where continuously operated re-circulating systems are used include, but are not limited to, residential care homes, hospitals and hotels. Continuously operated re-circulating systems are very different from conventional hot water supply and central heating systems found in domestic properties, for which our products have been tested to, under either BS 7291 Class S or WRAS approval standards, and for this reason PolyPlumb, PolyMax, PolyFit or PolySure must not be used on any continuously operated re-circulating systems. Some secondary hot water circulation systems are used intermittently, controlled by time and/or temperature thermostats. This application is also unsuitable for products manufactured to BS 7291.

Recycled rainwater systems

Polypipe products can be used in systems conveying recycled or harvested rainwater within domestic properties. All pipework used in this type of system should be clearly identifiable and this should be carried out in accordance with WRAS Information and Guidance Note No. 9-02-05; Marking and Identification of Pipework for Reclaimed (Greywater) Systems. If self-adhesive labels are to be used, these should not be applied directly to the pipe.

Chlorine and other additives

The polybutylene material used in Polypipe Plumbing and Heating Systems is WRAS approved. It is resistant to the build-up of scale. Normal levels of chlorine in UK domestic water supplies will not have an adverse effect on Polypipe Plumbing and Heating Systems.

However, Polypipe Plumbing and Heating Systems are not suitable for systems in which any further additives are ever added, periodically added, or regularly dosed into or additional to the normal UK mains water supply, for example chlorine for swimming pools or those used for bacteria control or legionella prevention. Systems must not be flushed through with anything other than water from the normal UK mains water supply or a cleaning product at the correct concentration that is specifically recommended for plastic piping systems.

The use of corrosion inhibitor in central heating systems is acceptable provided that the inhibitor is specifically designed for plastic piping systems and guidance on their suitability should be sought from the inhibitor manufacturer prior to adding to the system.

Electrical Safety/Equipotential Bonding

Where Polypipe pipes break the continuity of existing metal pipe, which may be used for earthing or bonding, this continuity must be re-instated by affixing permanent earth clips and a section of earth cable between the copper ends on either side of the plastic sections. Both the IEE and the Chartered Institute of Plumbing and Heating Engineers now give guidance on the Earth Bonding requirements of Plastic Pipe systems. As plastic pipes do not conduct electricity, installations generally require less equipotential bonding than metal systems although if in doubt exact guidance should be sought.

Light

Polypipe Plumbing and Heating Systems should be protected from UV light. Standard decorating paints form adequate protection. Pipe insulation forms adequate protection for external use. Polypipe products are delivered in light protective packaging.

Compatibility with other substances

For details of compatibility with building and cleaning substances and treatments (e.g. filler foam and wood worm treatments), please consult the relevant manufacturers to confirm suitability with polybutylene. Polypipe Plumbing and Heating Systems pipes and fittings can be painted using emulsion or undercoat and gloss. Cellulose based paints, strippers or thinners must not be used.

Vermin

There is no evidence to suggest that Polypipe Plumbing and Heating Systems attract vermin. Where vermin are present they can cause damage to other services, building fabric and pipes and fittings, and therefore a qualified pest controller should be employed to remove vermin from the affected area.

Use of aluminium tape

To comply with the NHBC guidelines regarding detection of pipes in wall cavities Polypipe recommends the use of aluminium tape. This tape should be applied directly to the wall sub-structure and pipes should be clipped on top of the tape. The tape must not be applied directly to the pipes.

"Dot and dab" walling

Dry lined or "dot and dab" walls are commonly used to speed up the build process and Polypipe systems are compatible with these types of constructions. Board adhesive or plaster should not be applied to Polypipe pipe and fittings especially around the area where the pipes pass through the wall to feed radiators and appliances. Pipes and fittings must remain accessible should future maintenance be required.

Handling and storage of products

The packaging of both pipes and fittings is designed to protect from ultraviolet light and environmental contamination.

Pipes and fittings should therefore be retained in their packaging as long as possible and should be stored in a cool dry area.

When on-site, fittings should be stored to prevent dust and debris from entering the fitting and sticking to the pre-lubricated 'O' ring. Care should be taken to avoid scratching the pipe surface during the handling, storage and installation processes.

Insulation of pipework

Pipes and fittings should be insulated to limit heat losses, heat gains and protected from potential frost damage in accordance with Part L of the Building Regulations, BS5422, BS6700 and BS EN 806.

Pipe support

All pipes should be correctly supported using either nail-in, snap-fit or bull dog clips. Where required spacer pieces are available for the snap-fit clips. All pumps and valves must be correctly supported to prevent unnecessary strain on the pipework.

Where plastic pipework is exposed it should be installed at the fixings centres below:

10mm & 15mm, horizontal 0.3m, vertical 0.5m
22mm, horizontal 0.5m, vertical 0.8m
28mm, horizontal 0.8m, vertical 1.0m

Concealed plastic pipes may be supported at greater centres provided the sagging is not excessive. Pipes spanning between joists at up to 600mm centres are normally acceptable for concealed pipework. The use of cable ties is permissible for concealed pipework. Cable ties should not be over tightened.

Drilling of holes/thermal expansion

Holes drilled in joists should be large enough to allow for the thermal movement of the pipe. Space should also be left between joists and fittings to accommodate thermal expansion and also for access to the sockets, should this be required.

Steel framed construction

Damage to the outside of the pipe when cabling through metal joists/struts/webs, etc. must be avoided. Pipe runs should be made through pre-made holes where possible. The use of rubber or plastic grommets is recommended.

Connections to other materials

Connection to Imperial copper pipe using PolyPlumb

Imperial 3/4" copper pipe is of significantly different size to its metric 22mm counterpart and therefore requires a different 'O' ring to that supplied in the 22mm fitting. The 22mm 'O' ring should be replaced with a 3/4" 'O' ring (PB9034). Standard 15mm fittings can be connected to Imperial 1/2" copper pipe, and 28mm fittings can be connected to 1" copper pipe.

Connection to Irish copper pipe

Irish copper pipe to IS238:1980 can be connected to PolyPlumb fittings which incorporate the 3/4" or 1" adaptor set. Using a standard 22mm or 28mm PolyPlumb fitting, remove the nut and socket components and discard. Replace these parts with the relevant adaptor set, 3/4" - PB7034 or 1" - PB701. The adaptor sets are distinguishable by the black cap-nut.

Connections to chrome plated and stainless steel pipework

PolyPlumb, PolyFit and PolyMax fittings should not be connected directly to chrome plated copper pipes or stainless steel pipes. To connect to these pipes we recommend the use of a compression coupler. A pipe stiffener should be used when connecting PolyPlumb, PolyFit and PolyMax pipe to a compression fitting.

Connecting PolySure press-fit fittings to copper

PolySure press-fit fittings have been designed specifically to fit to Polypipe grey and white plumbing and heating polybutylene pipes.

To connect to copper pipes we advise the use of a PolySure press-fit x BSP male or female adaptor, with the corresponding adaptor being used on the copper side from the PolyPlumb, PolyFit or PolyMax range. PTFE tape should be used to seal the mating brass components.

Connections close to capillary fittings

Capillary fittings should preferably be completed prior to the use of Polypipe fittings. Where this is not possible, care should be taken to ensure that flux or solder does not come into contact with plastic pipes or fittings. A damp cloth should be wrapped around the copper pipe close to the nearest plastic pipe or fitting to ensure against damage by conductive heat. Pipework should be flushed to clear flux before active use.

Connections to incoming cold water supply

There are two options for connecting incoming MDPE mains water service pipe to PolyPlumb, PolyFit and PolyMax pipe systems. Firstly the push fit x compression adaptors provide a one piece transition fitting covering connections from 20mm, 25mm and 32mm MDPE service pipes to 15mm, 22mm and 28mm polybutylene pipes and most sizes are available in both PolyPlumb, PolyFit and PolyMax versions. Secondly, as there is a requirement for a stopcock on the incoming main there is also a combined stopcock and adaptor which reduces the number of fittings required in a position where there is often limited space e.g. under a kitchen sink. These products allow connections from 20mm or 25mm MDPE pipe via a compression end to 15mm or 22mm polybutylene using a push-fit connection.

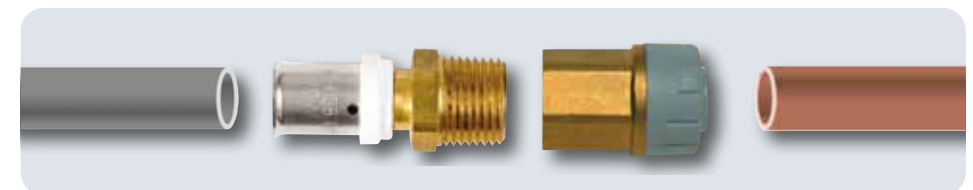



Boilers and appliances

All boilers and appliances must have safety devices such as thermostatic controls, cut-outs and pump over-run protection to make sure that they cannot operate above the Class S working temperature and pressure limits set out in the table of Class S service conditions on page 22. Exposure to conditions in excess of those specified could result in failure of the pipes or fittings with the potential for serious injury.

Gas boilers

Pipe should only be connected to gas boilers where the pipe connection is outside the boiler casing and where the boiler incorporates a high limit thermostat and pump over-run facility. The pipe connections should be 350mm from the heat source. In all other situations, a section of metal pipe should be at least 1m in length. In addition, for back boilers metal pipework should be used within the fire opening extending out of the chimney brickwork.

Combination boilers

Where system connections are made to an incoming water supply pipe from a water meter, or any other device which contains a check valve, a suitable expansion vessel must be fitted to prevent the expansion of heated water back down the supply pipe. This is especially important where a water meter is fitted retrospectively.

Solid fuel boilers and cooking ranges

Pipes and fittings must not be used for primary or gravity circuits from solid fuel boilers, cooking ranges or other uncontrolled heat sources.

Solar panels/systems

Pipes and fittings must not be used for connection of solar panels or any part of solar distribution that operates above the Class S working temperature and pressure limits set out in the table of Class S service conditions on page 22.

Oil fired boilers

Open vented central heating systems

The use of plastic pipe and fittings is acceptable when used in oil fired installations where the boiler is connected to an open vented system, however the first metre of primary pipework from the boiler connections must be installed using metal pipe.

The boiler must be suitable for this type of application and all relevant safety features as supplied and fitted to the boiler must be checked for correct operation. The system must also be commissioned in accordance with the boiler manufacturers instructions.

Plastic pipe and fittings can also be used in the hot and cold water and underfloor central heating systems with the exception of continuously operated re-circulating systems (see page 23) where plastic pipe and fittings should not be used.

For further information regarding the suitable applications for our plastic pipe and fittings please refer to the Class S Service Conditions table as shown on page 22 of this publication.

Sealed central heating systems

Where a sealed system oil fired boiler is to be used, all primary boiler pipework to and from the hot water cylinder (if fitted) and any radiator or towel rail circuits must be installed using metal pipe and fittings. Plastic pipes can be used on underfloor central heating systems where the plastic pipes are fitted after the UFCH control unit and manifold arrangement which must contain a correctly operating thermostatic mixing valve.

Plastic pipe and fittings can also be used in the hot and cold water system with the exception of continuously operated re-circulating systems (see page 23) where plastic pipe and fittings should not be used.

All relevant safety features as supplied and fitted to the boiler such as the boiler temperature control thermostat, high limit thermostat, pump overrun facility and the pressure and temperature relief valve, must be checked for correct operation at both installation stage and at any subsequent boiler service intervals. The system must also be commissioned in accordance with the boiler manufacturers instructions.

For further information regarding the suitable applications for our plastic pipe and fittings please refer to the Class S Service Conditions table as shown on page 22 of this publication.

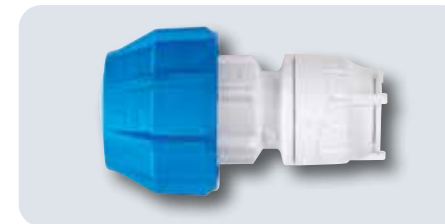

Push-fit X Compression Adaptor

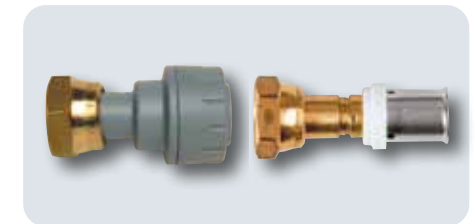

PolyPlumb and PolySure Swivel Tap Connector with Brass Nut



Combined Stopcock and Push-fit X Compression Adaptor

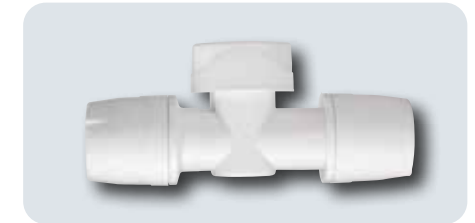

PolyMax Shut-off Valve



PolyMax Hand Tighten Tap Connector



PolyFit Straight Valved Tap Connector

Installation of pipework in floors and voids

Conduit Pipe and Pipe-in-Pipe

The conduit pipe coils (CPC15XX and CPC22XX) provide a conduit pipe which allows 15mm and 22mm pipes to be laid in a floor screed whilst conforming to water regulations.

The installation and application of the system is described in the following section. The conduit pipe used in conjunction with the conduit boxes (JIB1 and JIB3) which house fittings, provides a cost effective and practical pipework solution.

Polypipe Pipe-in-Pipe consists of a polybutylene barrier pipe encased within a black conduit pipe.

The conduit provides protection for the polybutylene pipe in the installation process as well as allowing easy withdrawal for future alteration or maintenance.

Installing conduit systems

Step 1: Positioning the conduit box

Loosely position conduit boxes where required.

Step 2: Assembling fittings

Assemble fittings in boxes.

HANDY TIP

Where boxes abut a wall, i.e. elbows beneath radiators or sanitary appliances, boxes can be cut in two with the open end abutting the wall, this reduces the number of boxes required.

Step 3: Positioning drill holes

Drill conduit box using fitting assembly to determine hole position.



Step 4: Fixing the conduit box

Fix conduit box to floor.

HANDY TIP

Use round drilled out sections of conduit box as washers.

Step 5: Preparing the pipe

Make joint at one end of pipe to be installed and cut pipe to length required.

Step 6: Cutting conduit pipe

Cut conduit to length required before threading conduit over pipe and through hole in the box to 2 or 3 corrugations.

Step 7: Securely fitting conduit pipe

Push away pipe from the end yet to be connected to allow grip onto the pipe. Push the pipe into the fitting before allowing conduit to cover pipe. Push conduit through hole in the box to 2 or 3 corrugations.



Joints in screeded floors due to accidental damage

Where it is necessary to have joints in screeded floors, these joints must be accessible. For example, where accidental damage to a pipe has occurred, the damaged section of pipe must be removed and replaced. The section containing the joints must be installed within a Junction Inspection Box. Junction Inspection Boxes are manufactured to suit two screed depths; 65mm (Product Code JIB3) - black in colour and 75mm (Product Code JIB1) - grey in colour. Both accept the 12mm plywood lid (Product Code JIB2) to provide future access should it be required.

PolyPlumb Terminal Fitting

Where wall mounted taps are being utilised the use of a conduit terminal box is recommended. The fitting consists of a 15mm x 1/2" female elbow which is housed in a plastic terminal box allowing the hot and cold water supply pipes to be hidden in a wall cavity. The terminal elbow can also be mounted onto a backing plate which assists installation and centering the taps. Once installed, taps can be screwed into the female threaded elbow and the wall finish applied to give a neat cleanly designed environment.



Connecting to radiators

As with connections to sanitary appliances there are a number of options for connecting pipes to radiators. Available within the ranges are spigot elbows for 10mm and 15mm connections as well as a 10mm x 15mm version which allows 10mm pipes to be connected directly into a 15mm radiator valve without the need for additional reducers. The Radiator Connector Bend "RCB" provides installers with an attractive method of connecting 10mm or 15mm Polypipe pipe from walls or floors to radiators. The rigid white 100mm x 150mm bend can be cut to length and connects directly to Polypipe fittings and radiator valves and requires pipe stiffeners in each end.



Radiator Terminal Plate

The Polypipe Radiator Terminal Plate is a multifunctional product for use in PolyPlumb, PolyFit and PolyMax piping systems.

- It provides an air tight seal around pipework entering rooms from wall cavities to feed radiators, helping developers to achieve air tightness levels required by Building Regulations
- Gives a neat and secure entry point for pipes serving radiators
- Ensures pipes are not damaged by rough edges of wall boards or plaster boards
- Can be fitted with or without a single gang electrical back box (supplied by others)

Product features

Holes sized to provide interference fit with pipes giving air tight seal



Three screw holes included for additional security

Three bosses allow use with single gang electrical back box if required or just act as a cutting guide for other trades

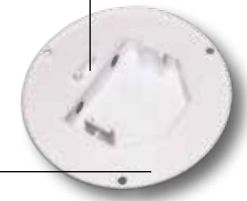

Can be fixed to wall boarding using panel adhesive

Radiator Terminal Plate installation instructions

Step 1: Installing flow and return pipework

Install 10mm flow and return pipework down sub-wall with continuous loop long enough for radiator feeds through wall. Pressure testing of the heating system must be carried out at this stage.



Step 2: Preparing the wall boarding

Cut a hole the size of a standard electrical back box in the wall boarding. For guidance use the three bosses on the reverse side of the Polypipe Radiator Terminal Plate.

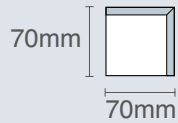

Step 3: Cutting the pipes

Cut pipes at appropriate point to allow for wall board to be installed ensuring enough pipe is left to reach valves at each end of the radiator.

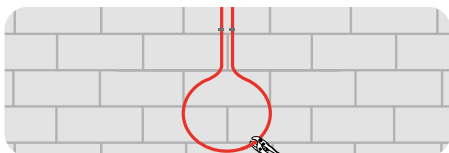

Step 4: Pipe threading

Thread pipes through hole cut in wall board taking care not to scratch or damage pipes.



Step 5: Fit Radiator Terminal Plate on to pipes

Pass the pipes through the Radiator Terminal Plate from back to front using the pipe guides to aid routing. There should be a tight interference fit through the holes which provides the seal. Cutting the ends of the pipes at an angle may help to thread pipes through the hole but remember to cut pipes square again before connecting into a fitting.

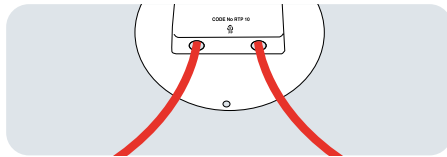

Step 6: Securing the Radiator Terminal Plate

Use panel adhesive to seal the Polypipe Radiator Terminal Plate to the wall board and if necessary use tape or three countersunk screws to hold the plate in position whilst the adhesive sets.

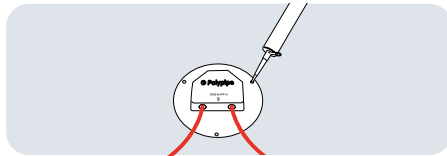

Step 7: Fitting the radiator

Fit radiator and valves and connect the pipes as per normal installation instructions.

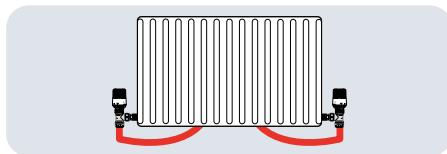

Manifolds

Pipe stiffeners are not required when using the spigot of a Socket/Spigot Manifold. Further information on pipe stiffeners can be found on page 7.

In instances where pipes have alternative adequate means of support or are run within concealed spaces (e.g. through floors or joists), the number of clips can be significantly reduced under the following conditions:

- There is absolutely no risk of the pipes or fittings coming into contact with potentially damaging surfaces (e.g. abrasive, sharp or destructive surfaces)
- Hot and cold pipes do not come into contact with each other
- Pipe distribution does not form a circuit where effective air venting could potentially be impaired by poor pipe alignment
- The pipe does not come into contact or close proximity with any material which may be affected by transmitted heat

Pipe and fitting blanking

Pipes and fittings may need to be temporarily or permanently blanked for testing, avoidance of construction debris or for future connections.

There are a number of options for blanking pipes in the PolyPlumb, PolyFit and PolyMax ranges. For example for permanent capping off of pipes we would recommend the use of a PolyPlumb socket blank (Product Code: PB19XX) or where blanking off is only a temporary measure then either a PolyPlumb demountable cap end (Product Code: PB69XX) or PolyFit socket blank end (Product Code: FIT19XX) is ideal.

Fittings can be blanked off using either a PolyPlumb blank end (Product Code: PB9XX) for permanence or a PolyFit version (Product Code: FIT9XX) which features handy finger slots for gripping when demounting when used in temporary situations.



PolyPlumb Socket Blank End



PolyPlumb Demountable Socket Blank End



PolyFit Socket Blank End

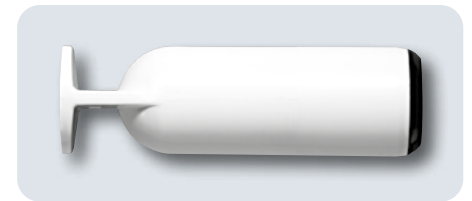

PolyFit Spigot Blank End



PolyPlumb Spigot Blank End



Releasable Stop End



Plumbing & Heating System testing

Pressure testing of the pipe system is essential. However a successful pressure test using the following steps is not a guarantee of complete and correct installation and only ensures that pipes have been inserted into fittings passed both the 'O' ring and the grab ring. If pipes have been scored or scratched during the installation process a high pressure test as below may not highlight these issues.

First fix installations

Pipe and fittings only should be tested. The system should be completely filled using water at no more than 20°C at a test pressure of 18 Bar which should be applied for no less than 15 minutes and no longer than 1 hour. Joint security can be checked visually and by tugging at joints.

Second fix installations

Complete installations including appliances should be tested with water to the maximum test pressure allowed by manufacturers of the appliances and fittings.

Please note, due to Health and Safety reasons Polypipe products must not be air tested.

Pressure testing in sub-zero temperatures

Special precautions are necessary if the pressure testing is to take place in sub-zero temperatures. This applies particularly in underfloor central heating systems using the screeded floor system where most of the pipe is encased in concrete. Due to the contact between pipe and floor panel on screeded installations, where the screed does not completely surround the pipe, there may be points where strain is created on the pipe in freezing conditions which is not normally present. Therefore it is advisable to drain the underfloor central heating system once testing and screeding has been completed. Precautions should also be taken where installations contain large quantities of fittings which, due to the rigidity of their construction, may put undue pressure on the pipe.



Underfloor Heating

Polypipe manufactures the most comprehensive range of underfloor heating systems available for the UK market.

Our range combines versions of traditional underfloor heating systems and a number of innovative product solutions. They're designed to extend the suitability of underfloor heating to almost any installation scenario, from whole house to single room projects and for new build and renovation.





Visit our website for the latest installation information –

Download the latest installation advice and watch our installation videos. Use our online product selectors and quotation tool.









www.polypipeufh.com

Guide to typical applications

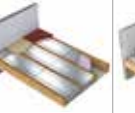
Type of project	PREDOMINANTLY NEW BUILD OR RENOVATION WHERE FLOOR REQUIRES EXCAVATION			NEW BUILD OR RENOVATION WHERE FLOOR LEVEL PERMITS
Floor construction	IN THE FLOOR SOLID/SCREED			OVER THE FLOOR FLOATING
System	RED FLOOR PANEL	CLIP RAIL	STAPLE SYSTEM	FLOATING FLOOR
Schematic				
General system description	Pipe laid on insulation prior to screeding and then sits within a 65mm screed			Pipe laid in 50mm thick pre-grooved insulation panels and then overlaid with structural chipboard floor deck
Typical floor build height (including insulation)	115mm with 50mm insulation			68mm with 18mm chipboard floor deck
Compatible heat source	Boilers and heat pumps			Boilers
Floor coverings	Tiles and ceramics, vinyl, wood laminate, engineered wood, solid wood and carpet			Tiles and ceramics, vinyl, wood laminate, carpet
Heat output at mean water temperature shown below	91W/m2 at 100mm pipe spacing	76W/m2 at 200mm pipe spacing	76W/m2 at 200mm pipe spacing	65W/m2
Mean water temperature	50°C	50°C	50°C	50°C
System benefits - Installer	<ul style="list-style-type: none"> Simpler, more accurate installation Precise pipe positioning Ensures minimum pipe bending radius achieved Quick and easy to use Can use in any size room Allows spiral configurations and 100mm pipe centres 	<ul style="list-style-type: none"> Fit directly onto insulation 	<ul style="list-style-type: none"> Minimum fixing materials needed 	<ul style="list-style-type: none"> Dry system, hence no screed and drying time Suitable for projects where access to wet screed may be difficult
System benefits - Consumer	<ul style="list-style-type: none"> Ideal for ground floors, new build or extensions Little if any change to floor construction Can be used with low temperature heat sources Use with all common floor coverings Can reduce the amount of screed content needed 			<ul style="list-style-type: none"> System can be used immediately after installation due to no drying time required Provides impact sound insulation when installed on intermediate floors

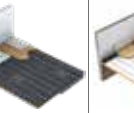
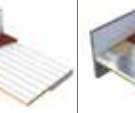
Optimum performance system

NEW BUILD AND RENOVATION				NEW BUILD/RENOVATION/EXISTING/SINGLE ROOM		
BETWEEN JOISTS SUSPENDED (TIMBER AND COMPOSITE JOISTS)				OVER THE FLOOR EXISTING STRUCTURAL FLOOR - SOLID OR TIMBER DECK		
DOUBLE HEAT SPREADER PLATES	OVERLAY™ LITE 15	FIT FROM BELOW (FFB) DOUBLE HEAT SPREADER	MODULAR HEATING PANELS (MHP)	OVERLAY™ PLUS	OVERLAY™	OVERLAY™ LITE 15
						
Fit from above grooved metal plate suspended between joists	Pipe fits into pre-formed grooves of panels/plates, which are cut to size and fitted in between joists	Fit from below grooved metal plate fixed to floor deck between joists	Pre-configured solution including pipes, supplied in sized panels which are fitted between joists from above or below	Pipe laid in pre-grooved rigid insulation panels between structural floor and floor covering	Pipe laid in pre-grooved gypsum fibre panels between structural floor and floor covering	Pipe laid in pre-grooved insulation panels between structural floor and floor covering
Within suspended floor void	Within suspended floor void	Within suspended floor void	Within suspended floor void	18mm	18mm	22mm
Boilers	Boilers and Heat Pumps	Boilers	Boilers and Heat Pumps	Boilers and Heat Pumps	Boilers and Heat Pumps	
Tiles and ceramics, vinyl, wood laminate, carpet				Ceramics, solid wood, carpet and LVTs.	Ceramics, solid wood, carpet.	Laminate, engineered wood, carpet
52W/m2	65W/m2	52W/m2	76W/m2	82W/m2	75W/m2	65W/m2
60°C	50°C	60°C	50°C	50°C	50°C	
<ul style="list-style-type: none"> Simple installation with traditional joists at typical 300mm to 450mm centres Suitable for 'sprung' flooring systems as used in sports halls, etc. 	<ul style="list-style-type: none"> Can be used with traditional joists System includes insulation and heat spreader layer System can be used with low temperature heat sources 	<ul style="list-style-type: none"> Can be used with both traditional or composite (I beam) joists Ability to fit even if the floor above has already been installed 	<ul style="list-style-type: none"> Pre-configured solution Can be used with both traditional or composite (I beam) joists Maximises heat efficiency System can be used with low temperature heat sources 	<ul style="list-style-type: none"> Low profile system allows simple installation of UFH without significant floor height gain or excavation of existing floor Fast response system 	<ul style="list-style-type: none"> Low profile system allows simple installation of UFH without significant floor height gain or excavation of existing floor Fast response system 	<ul style="list-style-type: none"> Fast response system - slightly deeper profile which can be used on top of a supporting floor or as a low profile alternative to floating floor Uses 15mm pipe so uses fewer circuits Suitable for larger areas or whole house solutions
<ul style="list-style-type: none"> Standard suspended floor detail normally associated with intermediate floor systems 	<ul style="list-style-type: none"> System compatible with heat pumps or allows boilers to run at lower temperatures for optimum efficiency 	<ul style="list-style-type: none"> Allows installation of heating without disturbance to upper floor e.g. cellars or where upper floor coverings are in situ 	<ul style="list-style-type: none"> System compatible with heat pumps or allows boilers to run at lower temperatures for optimum efficiency 	<ul style="list-style-type: none"> Ideal for single room applications Low profile option for new build Fast response systems 	<ul style="list-style-type: none"> Ideal for single room applications Low profile option for new build Fast response systems 	

Selecting the right pipe

At Polypipe Building Products we offer three different types of pipe for use in our underfloor heating systems:

Grey Plumbing and Heating Pipe

BS 7291 Class S. Manufactured from polybutylene and to the highest possible standard, this pipe is suitable for use in both underfloor heating and radiator central heating systems.

The pipe also incorporates an oxygen diffusion barrier so as to prevent the ingress of any oxygen into the system. An added cost saving advantage of using this particular pipe is that any remaining coil lengths or off cuts can also be used for the installation of the domestic hot and cold (potable) water services.

Ultra-Flexible Underfloor Heating Pipe

BS EN15876. Designed for use in underfloor heating systems, this ultra-flexible polybutylene barrier pipe lends itself perfectly to systems where ease of handling is essential, such as in solid floor pipe staple systems or fit from below installations.

Metal Composite Pipe (MCP)

BS EN21003. For those who prefer a more formable characteristic to laying pipe, we have introduced our 16mm MCP pipe range. Manufactured from raised temperature polyethylene (PE-RT) and incorporating an aluminium inner barrier layer this pipe is designed for use in underfloor heating systems only. This pipe has a practical application in rail and staple solid floor type installation.

Metal Composite Pipe installation

Pipe bending radius:

The 16mm x 2mm MCP pipe can be bent easily by hand to the flowing bend radius. $5 \times OD = 80\text{mm}$. If using a pipe spring this radius can be reduced to $4 \times OD = 64\text{mm}$.

Joining

The 16mm MCP pipe is connected to the underfloor heating manifold by the use of 16mm Eurocone adaptors. In order to make the joint correctly the following procedure should be used.

Step 1:

Cut the pipe at right angles using a suitable pipe cutter.



Step 2:

Use the chamfering tool to de-bur the inner wall of the pipe.



Step 3:

Place the cap-nut and split ring over the pipe.



Step 4:

Insert the brass body of the connector into the pipe.



Step 5:

Offer the pipe and connector to the manifold and tighten. Ensure that the outer and inner walls of the pipe are clean and free from grease deposits or any other contaminants.



Special jointing consideration

In areas where there is a risk of exposure to aggressive gases such as ammonia or where there is a possibility that excessive moisture will occur, it is recommended that any exposed joints be wrapped in a suitable adhesive waterproof tape. Please contact the Polypipe Technical helpline for more details.

Storage recommendations

Special consideration should be given to protecting the pipe when stored in temperatures below -100°C , as failure to do so could result in damage to the pipe composition. The pipe should also be protected from exposure to UV light. It is recommended that in order to provide adequate protection the pipe is stored indoors and in the original manufacturers packaging.

Clipping of Pipe

The recommended maximum clipping distances of the pipe is as follows:

- Horizontal runs 1.2m apart
- Vertical runs 1.5m apart

Underfloor Heating usage pipe table

PRODUCT	STANDARD	PIPE DIAMETER	OXY BARRIER	COIL SIZES (m)	MANIFOLD CONNECTION	SYSTEM USAGE	APPLICATIONS
Grey Plumbing, Heating and Underfloor Heating Pipe	BS 7291 Class S	15mm	Yes	50 80 100 120 150	Push-fit	Solid Floor, Clip Rail, Staple System, DHSP & Fit From Below Systems, Floating Floor System, Overlay™ Lite 15 System	Underfloor Heating, Radiator Systems and Hot & Cold (Potable) Water Installations
Ultra-Flexible Underfloor Heating Pipe	BS EN15876	12mm	Yes	25 50 80	Push-fit	Overlay™ & Overlay™ Lite Systems	Underfloor Heating Only
Ultra-Flexible Underfloor Heating Pipe	BS EN15876	15mm	Yes	50 80 100 120 150 500	Push-fit	Solid Floor, Clip Rail, Staple System, DHSP & Fit From Below Systems, Floating Floor System, Overlay™ Lite 15 System	Underfloor Heating Only
Ultra-Flexible Underfloor Heating Pipe	BS EN15876	18mm	Yes	120 150 200	Eurocone	Solid Floor, Clip Rail	Underfloor Heating Only
Metal Composite Underfloor Heating	BS EN21003	16mm	Yes	50 80 100 120 150	Eurocone	Solid Floor, Staple & Rail System	Underfloor Heating Only



System shown: Red Floor Panel

Underfloor heating for solid or screeded floors

Predominately installed in new build or renovation where a floor requires excavation - Polypipe Underfloor Heating offers three systems for solid or screeded floors: the unique Polypipe Red Floor Panel system which ensures accurate installation and positioning, and also the more traditional rail and staple systems.

Red Floor Panel

For optimum performance, Polypipe has the perfect solution for installing underfloor heating into solid or screeded floors. Utilising our unique lightweight plastic floor panels, which are quick and easy to cut to size, it is possible to fit Polypipe Underfloor Heating into any shaped room.

The lightweight plastic floor panels also nest for easy storage and carrying. Polypipe Red Floor Panels form a simple grid to ensure the fastest possible pipe laying and also provide a precise guide for the pipe, ensuring that the minimum pipe bending radius is achieved.

The panels are laid above pre-installed insulation and the system includes edge expansion strip to ensure maximum performance and efficiency.

Clip rail and staple system

We also provide a range of rail and staple systems that fit directly onto the insulation, offering a more traditional alternative to installing underfloor heating in solid or screeded floors.

 **Optimum performance system**

All systems

Solid floor systems are compatible with our 15mm, 16mm and 18mm pipe ranges.

Polypipe Underfloor Heating Systems can be used with the following solid floor constructions:

- Sand and cement screed (4:1 mix)
- Fine or heavy concrete
- Pumped screed systems (anhydrite etc.)
- Polymer modified screeds

NOTE: Once a screed is poured, the red floor panel will take up 15% of the volume of the screed.

Design and materials

	RED FLOOR PANEL	CLIP RAIL	STAPLE SYSTEM
KEY DESIGN INFORMATION			
Typical heat output at 50°C mean water temperature	91W/m ² at 100mm pipe spacing	76W/m ² at 200mm pipe spacing	76W/m ² at 200mm pipe spacing
Recommended design flow temp.	50°C	50°C	50°C
Maximum circuit length	100m	100m	100m
Maximum coverage per circuit	11m ² at 100mm centres 22m ² at 200mm centres 30m ² at 300mm centres* *(18mm pipe only)	22m ² at 200mm centres 30m ² at 300mm centres* *(18mm pipe only)	11m ² at 100mm centres 22m ² at 200mm centres
MATERIAL REQUIREMENTS (APPROX)			
Pipe	9m/m ² at 100mm centres 4.5m/m ² at 200mm centres 3.3m/m ² at 300mm centres* *(18mm pipe only)	4.5m/m ² at 200mm centres 3.3m/m ² at 300mm centres *(18mm Pipe only)	9m/m ² at 100mm centres 4.5m/m ² at 200mm centres
Floor panel usage	1 panel/m ² allowing for cutting (Actual 1.2m ² /panel)	N/A	N/A
Clip rail usage	N/A	1 x 1m rail/1m ² of floor area	N/A
Fixings	N/A	1 x bag (250 per 50m ² floor area)	N/A
Staple usage	N/A	N/A	1 box (300) staples for every 150m of pipe
Edge expansion strip	1.1m/m ²	1.1m/m ²	1.1m/m ²
Conduit Pipe	2m/circuit	2m/circuit	2m/circuit
Product dimensions	1.2m x 1m (Height 30mm)	1m lengths	60mm/40mm

Installation

Prior to installation it is recommended that the building is secured against the elements and that the sub floor is level, free from any mortar or plaster residues and is swept clean.

Solid floor - All systems

Fitting insulation

Step 1:

In accordance with Part 'L' of the current Building Regulations, a suitable layer of insulation material should be included within the floor construction. It is the responsibility of the architect or builder to ensure compliance. However, in all instances insulation must be installed beneath the underfloor heating system in order to ensure that any downward heat loss does not exceed 10W/m², in accordance with BS EN 1264.



Fitting the edge expansion strips

Step 2: Laying the insulation panels

When laying the insulation boards, ensure that the joints of each board are staggered and securely taped so as to minimise any risk of movement.



Step 3: Fitting the edging strip

Using the edge expansion strip allows the free expansion of the floor screed. The expansion strip comes with a self adhesive strip which bonds the panel to the wall, it should be installed around the perimeter wall and around fixed constructions such as columns, steps and access doors. The edge expansion strip also comes with a plastic skirt which lays over the top of the insulation panel and edge expansion strip. Edge expansion strip should be fitted in addition to perimeter insulation required by Building Regulations.



Solid floor - Panels

- 1 Insulation
- 2 Pipe
- 3 Red Floor Panel
- 4 Edge expansion
- 5 Screed
- 6 Finished floor

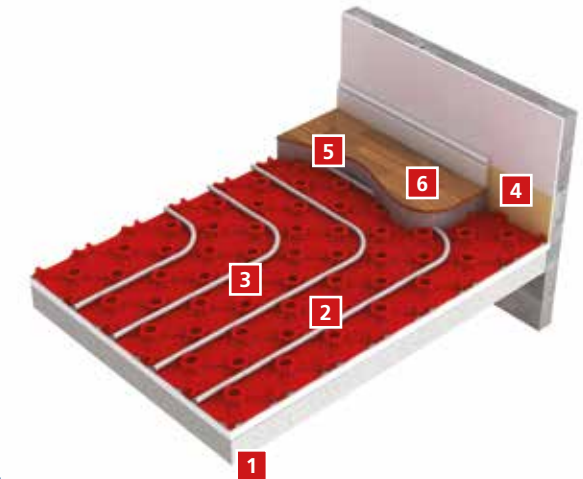

Panels step 4: Fitting the floor panels

The floor panels are laid over the pre-installed insulation and should be overlapped at the edges.



IMPORTANT Note:

The ½ castellation should overlap the ¾ castellation. The first panel should be laid with the ½ castellation edge against the wall. Panels can be cut by simply using a fine tooth saw, or it can be overlapped to the nearest castellation fit.

Floor panels should not be used at the base of the manifold as pipes need to be closer together than the floor panels allow. Pipes around this area should be secured using pipe clips which can also be used intermittently to secure the clip panel to the insulation. The plastic skirt should be laid over the floor panel and the outside run of pipe pushed into the skirt covered castellations to create a seal around the edge of the area.

When a pumped (liquid) screed is to be used it is essential that all of the panel joints are made correctly and that no panels are allowed to simply 'butt-up' as this may allow the screed to penetrate below the underfloor heating system and cause the panels to rise up. Similarly the panels should be firmly secured around the perimeter of the room using staples so as to prevent possible risk of the panels lifting.

Panels step 5: Preparing the pipe

You will need to remove the coil from the bag, leaving the shrink wrap on, uncoiling from the centre of the coil.



Panels step 6: Laying the pipe

Once you have completed laying the solid floor panels the pipe can be fitted starting at the manifold position in line with the pre-designed centres. 15mm and 18mm pipe can be laid at 100mm or 200mm centres as required, 18mm pipe can also be laid at 300mm centres. The minimum bend radius is achieved by encircling two castellations for a 90° bend or three castellations for a 180° bend.

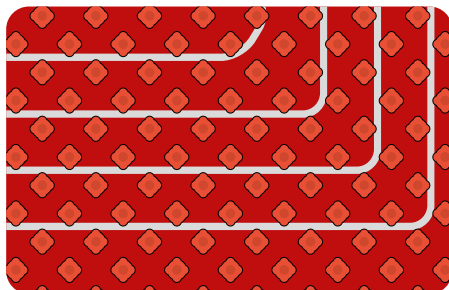

Panels step 7:

Circuits being laid at 100mm or 200mm centres must be laid in a spiral configuration. The first loop of pipe should be laid around the perimeter of the area to be covered by that circuit. The next loop of this circuit should be laid either 200mm from the first loop of pipe for 100mm centres or 400mm from the first loop of pipe for 200mm centres.

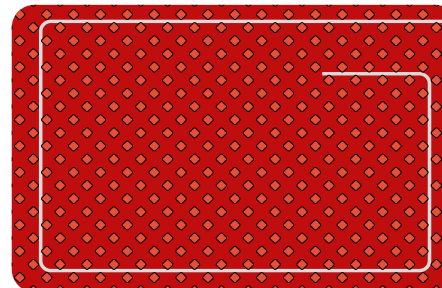
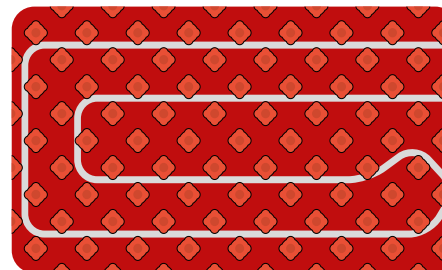

Panels step 8:

Continue to loop the pipe into the centre of the panels leaving enough space to form a double return ('S' shape in the centre of the loop).

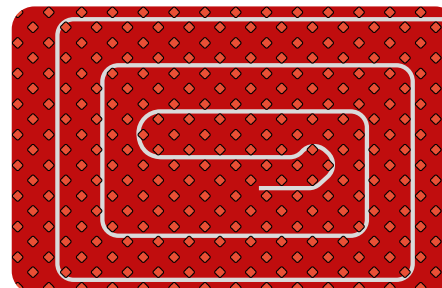

Panels step 9:

Now work back out from the centre by filling the space between the inwardly spiralling loop of the primary circuit ensuring the pipe is laid at the correct spacing centres.

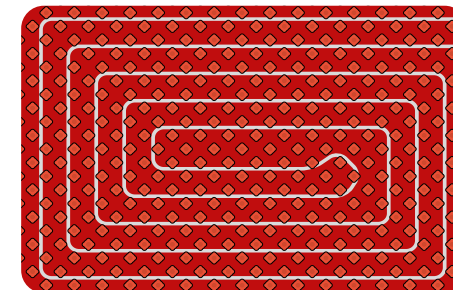

18mm pipe installation formation

Where 300mm centre spacing is required (18mm pipe systems only) a meander pattern can be used. The pipe simply crosses the room from one side to the other encapsulating 3 castellations at each return bend.

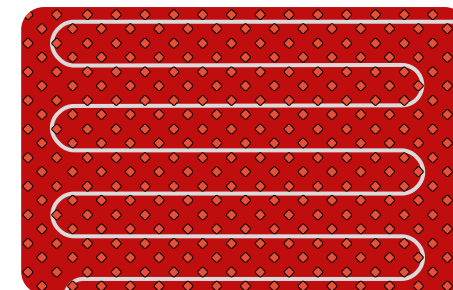

Solid floor - Clip Rail system

- 1 Insulation
- 2 Pipe
- 3 Edge expansion
- 4 Clip rail
- 5 Screed
- 6 Finished floor

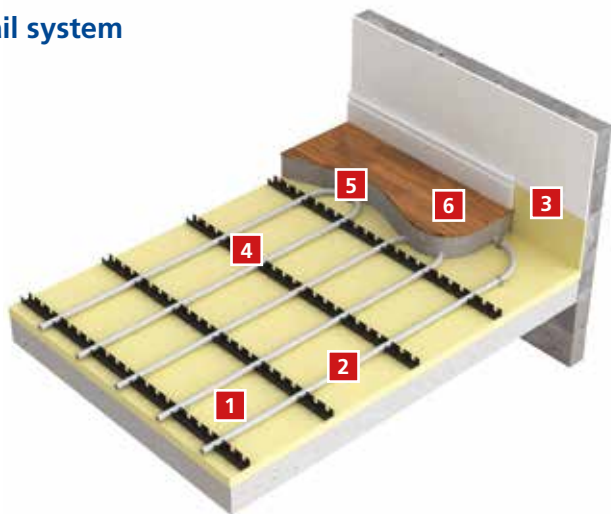

Step 1 - Step 3:

Follow steps 1, 2 and 3 from page 44 of the Solid Floor Systems section.

Rail step 4: Fitting the clip rails

Secure the clip rails to the insulation board by using the clips (PB02911). Firmly push the clips downwards into the insulation at 200mm centres so as to ensure that the clip rail is fully secured and lays flat to the insulation.



Continue to fit the clip rail across the room at 1m intervals making sure that sufficient space is left around the perimeters of the room (approx. 800mm) to accommodate any pipe returns or connection lengths back to the manifold. Care should also be taken to ensure that the clipping alignment is maintained.

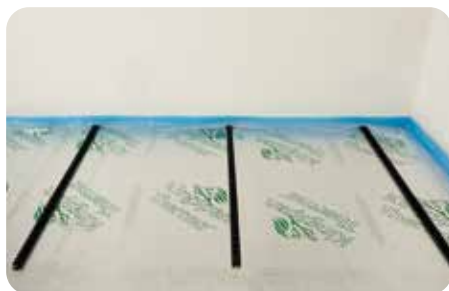

It is not necessary to overlap the clip rails. They can be clipped together end to end to form longer lengths.



Rail step 5: Laying the pipe

Fit the pipe into the clip rails at 200mm centres in a serpentine pattern and then bend the pipe at 180° at the end of each circuit ensuring that the edge of the bend is parallel with the adjacent circuit.



Continue to lay the pipe in this serpentine pattern until you have reached the end of the circuit.



If necessary use an additional clip or pipe staple (PB02930) to firmly secure the 180° return bends.



Continue to fix the pipe down using the pipe staples as you exit the pipe from the circuit. The plastic skirt should be laid over the insulation and the outside run of pipe stapled into the skirt covered insulation to create a seal around the edge of the area.



Solid floor - Staple system

- 1 Insulation
- 2 Pipe
- 3 Edge expansion
- 4 UFCH Staple Clip
- 5 Screed
- 6 Finished floor

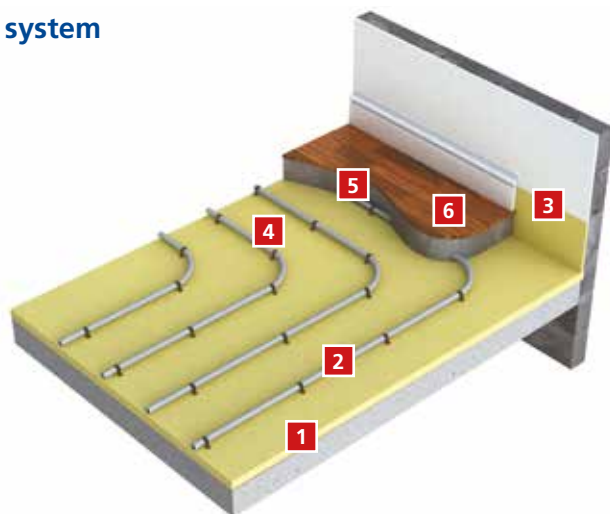

Step 1 - Step 3:

Follow steps 1, 2 and 3 from page 44 of the Solid Floor Systems section.

Staple step 4: Using the Staple Gun

Load the staples from the top and secure with the plastic weight so to ensure the staples stay in position.



Staple step 5: Fitting the pipe

The pipe should be laid in the same spiral or serpentine pattern as the panel system with the staples fixed at a minimum of 500mm centres.



The pipe should be installed at 200mm centres.



The plastic skirt should be laid over the insulation and the outside run of pipe stapled into the skirt covered insulation to create a seal around the edge of the area.

All solid floor systems

Conduit Pipe

A 400mm length of conduit pipe should be fitted over the underfloor heating pipe in any situation where damage may be caused to the pipe i.e. where the pipe passes through internal walls or doorways, where the pipe emerges through the floor up to the manifold or where the pipe passes through either an expansion or day joint. Preformed long radius bends can also be used to provide a neater solution if required.

A section of conduit pipe 400mm long should be fitted around the heating pipe where the pipe passes through the edge expansion strip, e.g. room to room, or through expansion joints within the floor.

Conduit pipe should also be used where the pipe leaves the floor adjacent to the manifold. This can be threaded down the pipe after the pipework has been installed.

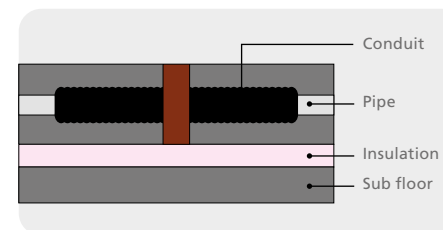

Expansion joint

BS EN 1264-4 recommends that an expansion joint is constructed in stone and ceramic finished screeds for every 40m² of floor area at a maximum length of 8m and an aspect ratio of 2:1. An expansion joint is also required in long narrow areas such as corridors etc.

The image (to the left) shows a typical arrangement where the pipes pass through either an expansion or a day joint. A strip of edge expansion is used to provide the expansion capacity.

For further information regarding floor screeding requirements for underfloor heating systems please refer to BS8204-1 or the BISRIA Guide: Screeds with Underfloor Heating.



Step 9: Testing

BS EN 1264-4 recommends that an expansion tightly compacted around the pipe to ensure that no voids are present. The system should remain under pressure (6 bar) in order to prevent the risk of any damage being caused to the walls of the pipe whilst the screed is being applied.

* (See page 92 for frost protection)

Step 10: Laying the screed

The overall quality and thickness of a sand and cement screed should meet the requirements of BS8204-1 which stipulates that in domestic or light commercial applications a minimum thickness of 65mm should be used. The thickness of alternative coverings, such as anhydrite or polymer modified screeds, may differ depending on construction requirements. This information should therefore be provided by the specialist screed manufacturer/supplier.

Under no circumstances should the underfloor heating system be used to artificially dry/cure the screed as this could cause the screed to crack and seriously undermine the integrity of the floor construction. Once the screed has fully cured, the underfloor heating system can be switched on and the manifold flow temperature slowly increased by increments of 5°C up to the calculated design temperature.

Finishing

Timber floors

The use of timber flooring is perfectly acceptable with our solid floor underfloor heating systems. However, care must be taken to ensure that the product being used is suitable for use with underfloor heating (please consult your specialist flooring supplier). It is essential that the new screed floor is allowed to dry out completely before the timber flooring product is laid. It is recommended that the underfloor heating system be run for at least two weeks to completely dry out the subfloor prior to the laying of the timber flooring product.

If you are using a natural timber flooring product then it should be allowed to acclimatise sufficiently prior to installation. The timber floor can be either 'floated' or 'glued' to the screed floor depending on the product type and installation preference.

When designing the system, care must be taken to ensure that floor surface temperature (at the floor interface) does not exceed 27°C.

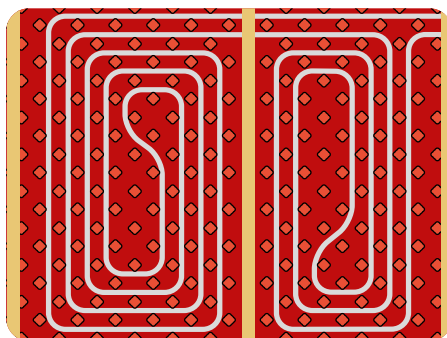

Application of timber floors over solid floor systems

Where solid oak flooring is to be laid on a solid floor, joists can be fitted at 1m centres to provide a fixing point for the boards. Insulation, solid floor panels and pipe can be laid between the joists and screed laid level with the top of the joists (see diagram above). Individual circuits of pipe are then laid between each set of joists with care being taken to ensure the screed is completely dry prior to fitting the solid oak covering (see diagram below).

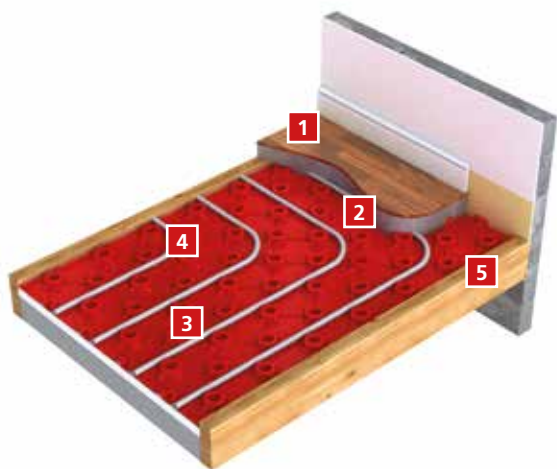

- 1 Timber floor covering
- 2 Screed
- 3 Pipe
- 4 Solid Red Floor Panel
- 5 Joists at 1m spacings





Underfloor heating for floating floors

The Polypipe Floating Floor System is designed for use in applications where a solid floor installation is not suitable due to structural weight limitations or where a 'dry build' floor option is required. Suitable for use in either new build or existing properties, the floating floor panels can be installed directly on top of both solid and timber floors.

The 50mm thick high density polystyrene panels have a thermal value of 0.036W/mK and can be used to enhance the thermal insulation requirement of the floor structure as necessary under current Building Regulations.

However, care should be taken when installing floating floor panels on top of a primary insulation layer to ensure that excessive deflection does not occur in the final floor construction. It is therefore recommended that any other insulation materials used below the floating floor panels are of a high density construction (100kN/m2 at 10% compression min).

Design and materials

KEY DESIGN INFORMATION	
Typical heat output at 50°C mean water temperature	Approx. 65W/m2 at 200mm pipe spacing
Recommended design flow temp.	45-60°C
Maximum circuit length	100m (15mm pipe)
Maximum coverage per circuit	20m2
MATERIAL REQUIREMENTS (APPROX.)	
Pipe	4.5m length/m2
End returns	0.5 x end return per panel
Floating Floor panel	0.96m2 per panel
Dimensions	Panel: 1200mm x 800mm x 50mm End return: 800mm x 300mm x 50mm

Pre-installation planning and room layouts for Floating Floor

Floating Floor consists of system panels and end return/transition panels. Although return bends are pre-formed in the panel moulding, the use of end returns for both transition pipes and around manifolds provides greater flexibility when planning pipe layouts and connection lengths.

Pipe layouts in multiple room installations

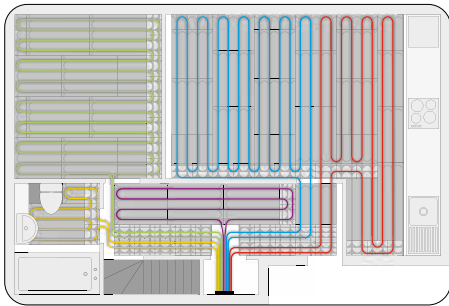

In transition areas such as hallways and corridors a combination of end return/transition and full panels can be used in order to accommodate the pipe connection lengths and any dedicated circuit(s) for that area.

It is also acceptable to run the connection lengths at floor level alongside the edge of the panels if insufficient space is available within the panels themselves.

In the area of floor directly below and in front of the manifold the pipework can be secured in place by clipping the pipe to a Floating Floor panel laid upside down and using our pipe clips or staples.

Installing multiple circuits

When a room requires two or more pipe circuits the end return panels can be used to provide easy access for the connection lengths.

Step 1:

In this example the room needs two circuits so a single run of end return panels are first laid along one side of the room as shown.



Step 2:

The first section of Floating Floor panels can then be laid.

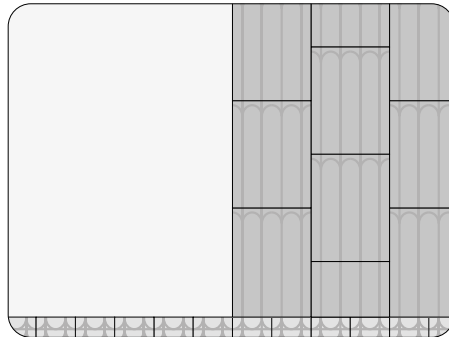

Step 3:

Once the first lot of panels are laid a second row of end return panels should be laid as shown.

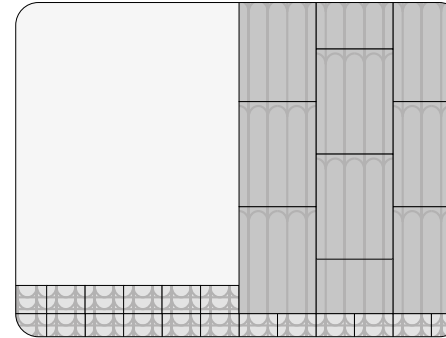

Step 4:

Finally the remaining section of Floating Floor panels can be laid in place to complete the installation.

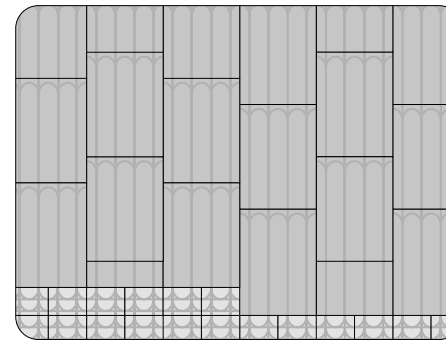

The connection lengths

The Floating Floor end return panels can also be used in hallways and corridors where it becomes necessary to use these areas for circuit connection lengths.

In the example, as shown below, the end return panels have been used to provide both heating into the area and to convey the connection pipework to other rooms.

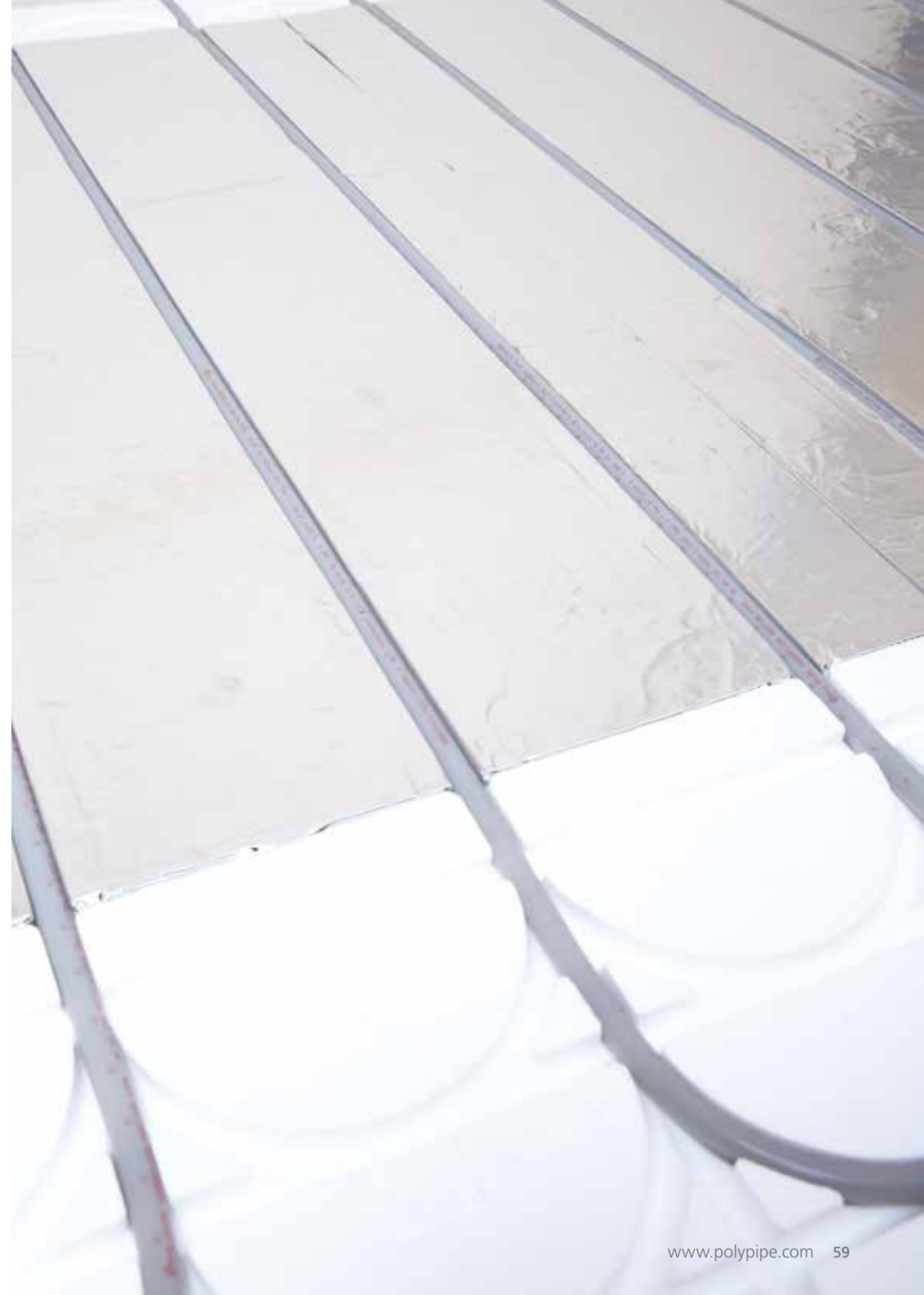
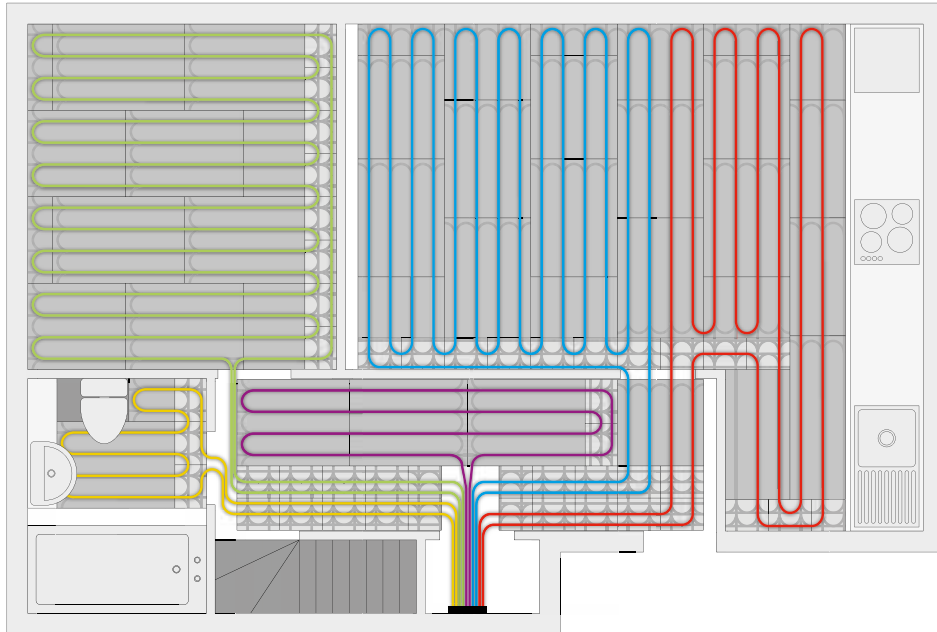

Installation - Floating Floor for larger floor areas

- 1 Fits over concrete or floorboards
- 2 Floating Floor panel
- 3 Pipe
- 4 End return
- 5 Chipboard floor deck
- 6 Suitable for laminate and engineered wood floor direct

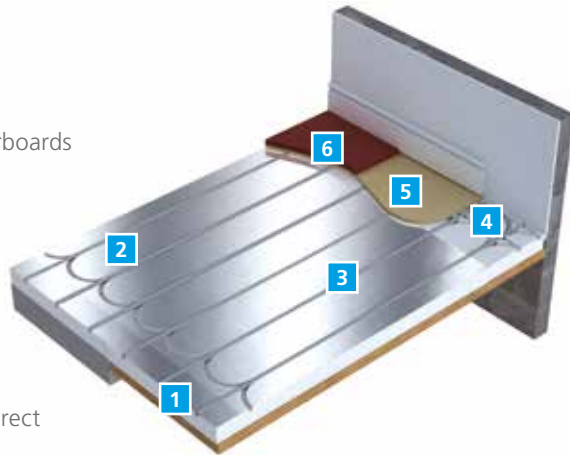

Step 1: Laying end returns

Begin by fitting a row of end return panels along one wall of the room. The end return panels should be suitably fixed down to the sub floor using screws.



Step 2: Laying the panels

Lay the first line of panels ensuring that the grooves in the end returns are aligned correctly with the grooves in the panels. Use short lengths of pipe to ensure this alignment.



Step 3:

When you reach the opposite wall place two more end returns in place and if necessary measure and cut a panel to suit to complete the row.

Cutting the panels

Panels can be cut using a handsaw.

Step 4:

Repeat this procedure until the floor area is complete.



Step 5:

At this point apply the self-adhesive foil tape to the vertical joints in the panels only so as to hold them securely in place.

Step 6: Laying the pipe

Starting from your manifold position and allowing enough pipe for connections, lay the pipe into the grooves of the floating floor panel in accordance with any design documentation.



Step 7:

Once the pipe has been laid complete the installation by taping up all of the remaining joints including those where the panels meet the end returns.



Finishing

The room can then be finished by fitting 18mm or 22mm tongue and groove sheets of chipboard, glued on the edge, over the floating floor system. Mark the position of the pipe where door thresholds or carpet strip are to be installed.

When laying a ceramic or stone floor covering ensure that any deflection in the floor is minimised. It is recommended that a slip mat or uncoupling membrane is used rather than a second layer of wood.

Suspended Floor Systems

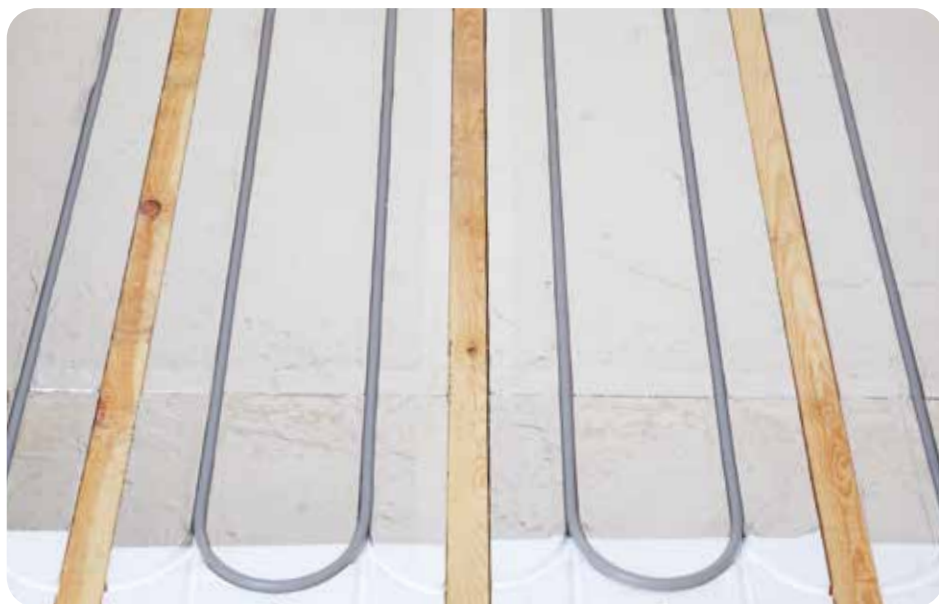

System shown: Overlay™ Lite 15 - Suspended floor application

Underfloor heating for suspended floors

For suspended timber and composite joists, typically found in new build and renovation projects, Polypipe offers a range of unique pre-insulated and pre-configured systems, as well as more traditional suspended floor underfloor heating options; giving you a solution for every type of suspended floor installation.

Double Heat Spreader Plates (DHSP)

Offering a simple installation system for traditional joists and spacings, double heat spreader plates can also be used in 'sprung' flooring systems such as sports halls. This system uses aluminium double heat spreader plates to transmit the heat evenly across the finished floor surface.

Fit From Above with Overlay™ Lite 15 - Suspended floor application

For enhanced performance, especially over larger floor areas, use our new Overlay™ Lite 15 panels for an integrated insulated solution.

 Optimum performance system

Fit From Below (FFB) Double Heat Spreader Plate

Suitable for use with traditional or composite joists, this system offers the ability to fit from below, even if the floor above has already been installed. Perfect for cellars or where upper floor coverings are already in place.

Modular Heating Panels

For the ultimate quick and easy installation solution, use our pre-configured, insulated panels that include all the system components already integrated. The panels are supplied in sized panels which are simply fitted and connected together on-site.

All systems

For use with our 15mm pipe systems. All suspended floor systems are fitted within the joists so do not add any build height to the floor.

Design information

	DOUBLE HEAT SPREADER PLATE 50M2 AT 225MM PIPE CENTRES	FIT FROM BELOW (FFB) DOUBLE HEAT SPREADER PLATE	OVERLAY™ LITE 15 - SUSPENDED FLOOR APPLICATION	MODULAR HEATING PANELS (MHP)
KEY DESIGN INFORMATION				
Typical heat output at 55°C mean water temperature (50°C mean water temperature for MHP only)	Approx. 91W/m2 (Max 0.5 TOG)	Approx. 80W/m2 (Max 0.5 TOG)	Approx. 68W/m2 (Max 0.5 TOG)	Approx. 76W/m2 (Max 0.5 TOG)
Recommended design flow temp.	60°C	60°C	50°C	50°C
Maximum circuit length	100m	100m	100m	N/A
Maximum coverage per circuit	22m2 at 225mm average pipe spacing (15mm pipe)	22m2 at 225mm average pipe spacing (15mm pipe)	22m2 at 200mm pipe spacing	20m2 approx. coverage required 70W/m2 80% of floor 50W/m2 60% of floor
Dimensions	450mm x 1000mm x 0.5mm	310mm x 1000mm x 0.5mm	1200mm x 800mm x 22mm (cut to fit joists)	30mm deep
MATERIALS REQUIRED				
Pipe	4.5m/m2	4.5m/m2	4.5m/m2	See product information table on page 75
Heat Spreader Plates	2 plates/m2	2 plates/m2	N/A	
Overlay™ Lite 15 Floor Panels	N/A	N/A	1 panel/m2	
End Returns	N/A	N/A	0.5/m2	
Aluminium Tape	N/A	N/A	1 roll per 10m2	
Conduit Pipe usage	2m/circuit	N/A	N/A	

Installation - fitting from above Double Heat Spreader Plates

- 1 Ceiling
- 2 Supporting joists
- 3 Insulation
- 4 Double Heat Spreader Plate
- 5 Pipe
- 6 Timber or chipboard floor deck

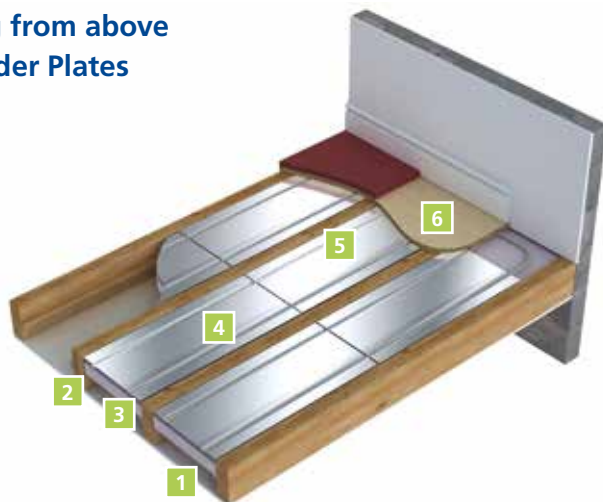

Step 1: Fitting insulation

Before installing a suspended floor system it is necessary to insulate between the joists. Polypipe recommend that a rigid polystyrene or foam insulation material is used.

Step 2: Fitting the spreader plates

The insulation layer should fit tightly between the joists directly below the spreader plate to ensure that the spreader plate is supported and therefore remains in contact with the underside of timber floor covering. This is necessary to eliminate any air gaps or draughts between the underfloor heating system and the floor. Any other services, such as drainage or electrical wiring, should be installed below the insulation layer.

The floor joists then need to be notched or drilled in accordance with Building Regulations. This facilitates the passage of the pipe between the joist gap to allow the entry and exit of the pipe to and from the room. The spreader plates can then be fixed evenly across the joists and in accordance with your installation design.

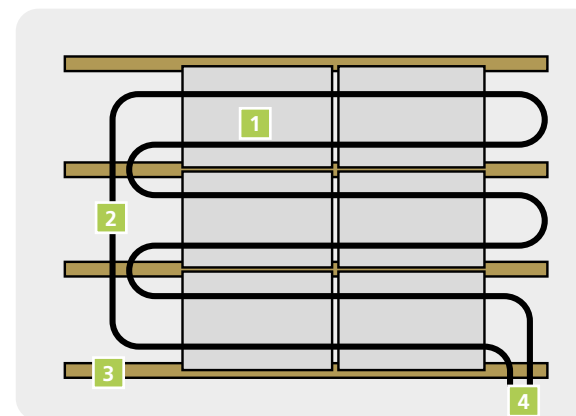

- 1 Double Heat Spreader Plate
- 2 Pipe
- 3 Joists notched to accept pipe returns
- 4 Return/flow

Step 3: Laying the pipe

Once the spreader plates have been fixed in place, the pipe can be fitted into the grooves in a meander pattern. It is recommended that the flow pipe from the manifold be taken to the furthest point of the room when installing the circuit, as this ensures that sufficient heat is provided around the perimeters of the room.

Care should be taken when installing the pipe to ensure the spreader plates are not pushed downwards and away from the underside of the timber finished floor covering as this could lead to potential under performance of the system.

Step 4: Testing

Once the pipe circuits have been installed and connected to the manifold, the system should be pressure tested to 6 bar for a minimum of 1 hour before the timber floor covering is laid. It is recommended that the system remains under pressure whilst the flooring is laid.

* (See page 92 for frost protection)

Overlay™ Lite 15 - Suspended floor application

- 1 Ceiling
- 2 Supporting Joists
- 3 Overlay™ Lite 15
- 4 Pipe
- 5 Timber or chipboard floor deck



Step 1:

Fix the battens as used to support the timber board to ensure that when the 22mm Overlay™ Lite 15 panel is installed, surface contact with the underside of the floorboards is achieved.



Step 2:

Measure in between joists and then cut the panels to size before laying them on top of the prefixed battens.



Step 3:

Cut the Overlay™ Lite 15 panels to size - the preformed line on the back of the panel indicates the centre line i.e. 400mm.

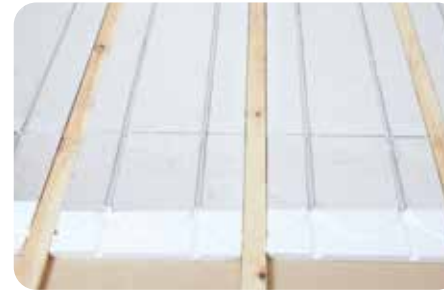

Step 4:

Lay the panels onto the timber board leaving a gap at one end so as to facilitate notching the joists. Please follow the industry guidelines for notching requirements (0.07 to 0.25 of the span).

NOTE:

No end returns are required in Overlay™ Lite 15 suspended floor system.



Step 5:

Working from a temporary board, screw the panels to the timber board so as to prevent any movement.



Step 6:

Lay the pipe into the grooves of the panels taking care to form a smooth bend at one end.



Step 7:

Once the circuit has been laid, the pipes can be taken out of the room using the notches in the joists as provided.

Step 8: Testing

Once the pipe circuits have been installed and connected to the manifold, the system should be pressure tested to 6 bar for a minimum of 1 hour before the timber floor covering is laid. It is recommended that the system remains under pressure whilst the floor is laid.

* (See page 92 for frost protection)

Installation - fitting from below Double Heat Spreader Plates

- 1 Supporting joists
- 2 Insulation
- 3 FFB Double Heat Spreader Plate
- 4 Pipe
- 5 Timber or chipboard floor deck
- 6 Ceiling



Step 1: Fitting the spreader plates

Fix the fit from below spreader plates to the underside of the timber decking. The floor joists can then be drilled in accordance with Building Regulations so as to facilitate the passage of the pipes between the joist gaps and to allow the entry and exit of the pipes to and from the room.



Step 2:

Once the spreader plates have been fixed in place the pipe can be fitted into the grooves in a serpentine pattern. It is recommended that the flow pipe from the manifold be taken to the furthest point of the room when installing the circuit as this ensures that sufficient heat is provided around the perimeters of the room.



Step 3: Fitting the insulation

It is essential that a suitable layer of insulation material is installed directly beneath the panels so as to minimise any downward heat losses. It is recommended that the thermal resistance of this insulated layer should not be less than 0.75 m²K/W as specified in BS EN1264-4.



Step 4: Testing

Once the pipe circuits have been installed and connected to the manifold, the system should be pressure tested to 6 bar for a minimum of 1 hour before the timber floor covering is laid. It is recommended that the system remains under pressure whilst the flooring is laid.

* (See page 92 for frost protection)

Finishing

Step 5: Laying a timber floor covering

It is strongly recommended that the timber floor covering is laid immediately after the underfloor heating pipes have been installed and pressure tested to eliminate any risk of damage to the system by other trades.

Either traditional tongue and groove floorboards or 18mm/22mm chipboard can be fitted directly on top of the spreader plates. These can be fixed directly through the spreader plate into the joists below. It is important to indicate the position of pipework in areas where additional fixing of items such as, carpet grip rod or door threshold strips may be fitted at a future date.

Polypipe does not recommend the application of two layers of timber floor covering as this will severely reduce the heat output of the underfloor heating system.

Correct application ✓

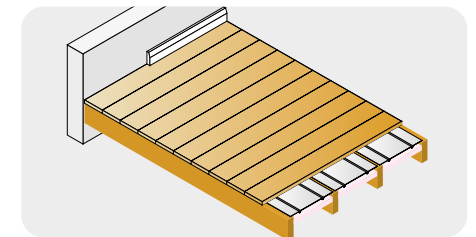

Incorrect application ✗

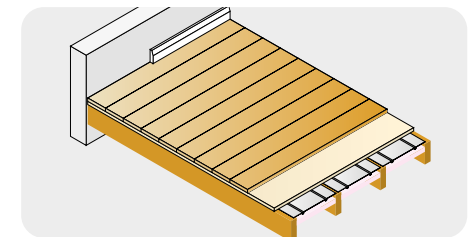

If a manufactured timber floor is to be used then it is recommended that this be of a suitable load bearing quality. (Please request advice from the specialist flooring supplier.)

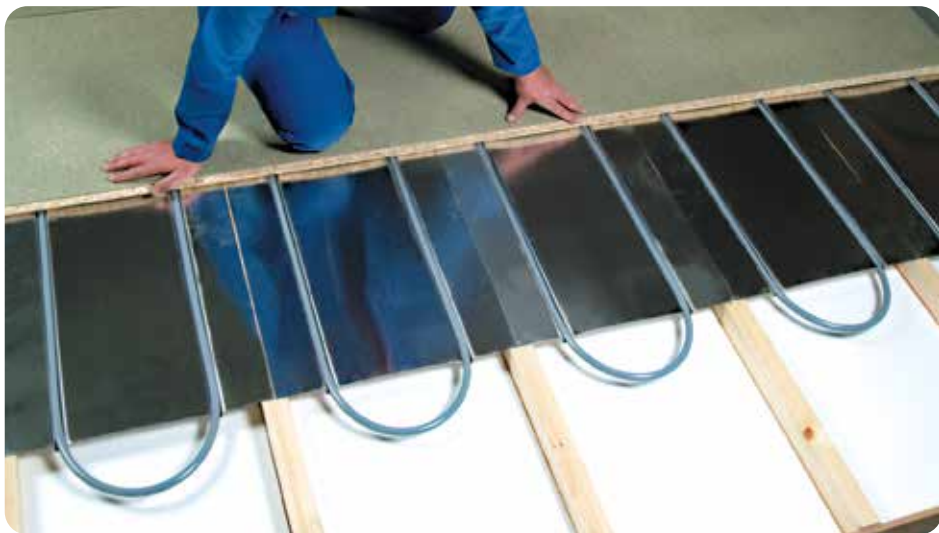

Batten systems (DHSP only)

Used for spans greater than 450mm or less than 350mm. Where it is not possible or desirable to drill or notch the floor joists, and the floor height can be raised, spreader plates can be used.

Step 1: Fitting insulation with a batten system

To prevent downward heat transmission, insulate between the voids in the joists with appropriate foam insulation.

Step 2: Fitting the battens

Lay 75mm x 25mm battens across the existing joists at 450mm centres. Trim the ends of the batten back to the last joist at alternative ends.

Step 3: Fitting the spreader plates

Lay spreader plates between the battens and pin into position.

Step 4: Laying the pipe

Lay pipe into the spreader plates in accordance to the installation instructions on page 67, ensuring you follow the testing procedure.

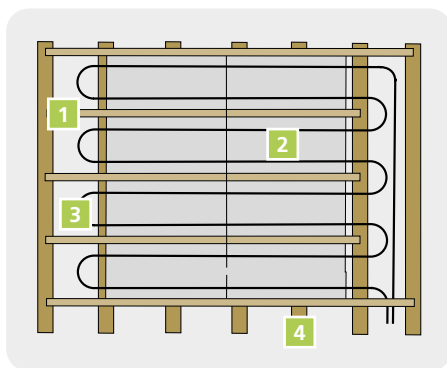

- 1 75mm x 25mm battens at 450mm centres
- 2 Double heat spreader plate
- 3 Pipe
- 4 Joists at spacing greater than 450mm or less than 350mm

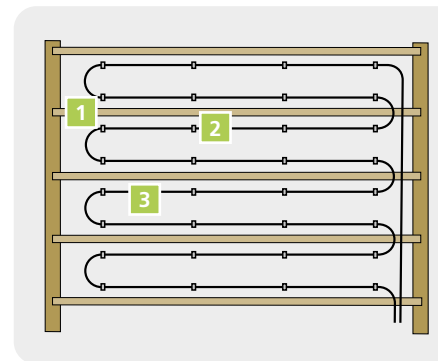

- 1 Joists at spacing greater than 450mm or less than 350mm
- 2 Pipe clip
- 3 Pipe

Pipe only systems

The use of heat spreader plates is recommended, as they assist the response time and heat dispersion. However, in some circumstances, simply laying the pipe in an air void between foil faced reflective insulation and the underside of the floorboard will be adequate.

The space between the top of the insulation and the underside of the floor deck should be kept to a minimum (20mm) and care should be taken to ensure that the insulation is sealed at the edges and ends.

Pipe only applications are suitable in areas where the heating response is less important, e.g. bedrooms and is not recommended in living spaces or over unheated spaces, e.g. rooms above garages.

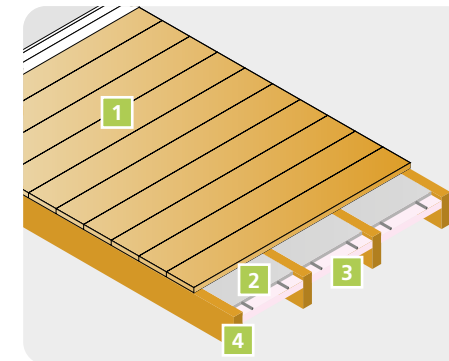

- 1 Tongue and groove flooring
- 2 25mm thick dry mix screed
- 3 Insulation
- 4 Joists

Enhancing pipe only systems

The effectiveness of pipe only systems can be enhanced by laying a weak (1:6) dry mix screed approximately 25mm thick between the joists.

In order to apply this, extra support may be required below the insulation. Although pipe only systems are designed to operate at 60°C flow temperature, the flow temperature may be reduced in these circumstances.

Before this system is considered it is suggested you consult a structural engineer to confirm its suitability.

Installation - Modular Heating Panels (MHP)

- 1 Ceiling
- 2 Supporting joists
- 3 MHP panel including pipe, insulation and foil diffuser
- 4 Timber or chipboard floor deck

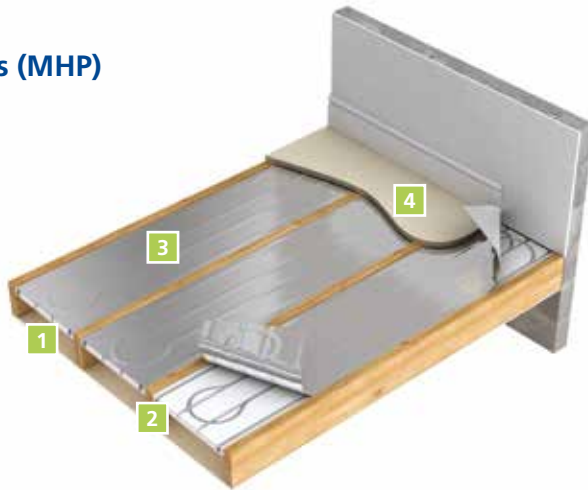

Modular Heating Panels are an exciting new product concept from Polypipe that enable quick and simple installation of underfloor heating into suspended floors in both new build and renovation projects. Installing underfloor heating into upper floors can be challenging, even in new build projects. Most conventional underfloor heating systems comprise of a single section of pipe, housed or placed within another part of the system structure, such as floor panels, which are cut to size on-site. This works fine as there are no interruptions to the laying of the pipe. In suspended floor installations however, the pipe, plates and insulation have to fit within an obvious obstruction: the supporting floor joists. It is working around the joists and avoiding other services, that has often led to underfloor heating being avoided in upper floors.

As the name suggests, a Modular Heating Panel (MHP) is a pre-configured solution where all of the floor heating system components are supplied fitted within complete panels and then simply fitted and connected together on-site. Thanks to MHP it is now possible to fit panels quickly into the existing joist voids and connect them to a standard heat source. MHP works with both traditional and composite joists and can be fitted from above or below.

Designing your layout

Designing the ideal room layout for an MHP installation and selecting the required products couldn't be simpler. Follow the steps below or use the online product selector tool at www.polypipe.com/plumbing-heating

Step 1: Select panel width

The spacing of joists and the available gap will determine which MHP panel width will be most suitable for each project. Select the MHP width nearest to the gap width, ensuring that this does not encroach on the space for other services. The 490mm width panel will normally be fitted in the wider joist spacing used by composite joists and 'I' beams.

Step 2: Select panel length

The span of the joists in each room will determine which MHP panel length should be selected. The span is defined as the free space from wall to wall that needs to remain uninterrupted by trimmers or other services. Ideally, install MHP panels prior to other services whenever possible.

Use the table below as a quick guide to suitable arrangements of MHP panels leaving a 200mm gap for pipe connections.

Arrangement	Span
1 x 1.3m Panel	1.4m to 2.2m
1 x 2.0m Panel	2.2m to 2.8m
2 x 1.3m Panels	2.8m to 3.5m
1 x 1.3m Panel + 1 x 2.0m Panel	3.5m to 4.2m
2 x 2.0m Panels	4.2m to 5.0m

Step 3: Planning your room arrangement

Calculating the amount of floor area to be covered by MHP will be based on the required heat output (see our heat output table on page 75) and will take into account areas of the floor that do not require heating, such as under built-in wardrobes, baths and shower cubicles. The diagram below illustrates a typical layout that might be considered.

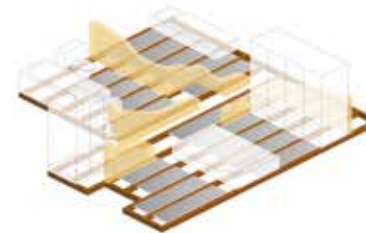

Pre-installation requirements

Planning

Before installing MHP panels ensure you have planned out the positioning of the required panels, avoiding all other services such as electrics, gas and water supplies. You will not need to do any specific preparation for the installation in a new build property as there will be no ceilings or floors in place. For existing room refurbishment, you will need to take up your floor if fitting from above, or take down the ceiling if fitting from below. Ensure that the area where the MHP panels are to be positioned is free from any debris before commencing installation.

Installation

Installation from above

To install MHP panels from above simply fit support bearers to each side of the joists. These support bearers should be positioned 30mm from the top of the joist and the MHP panel is then simply laid onto these supports.

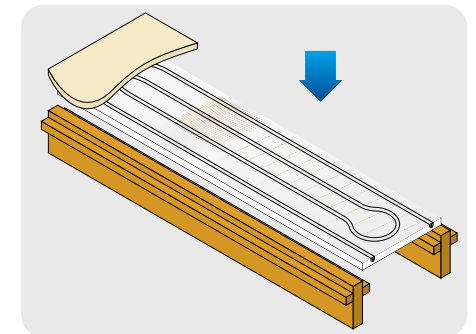

Installation from below

When installing MHP panels from below you will need to mark out the positioning of the panels to ensure you have them situated in the correct places for heating the room above. Once you have checked the marked out positioning, the MHP panels can be slotted into place and fixed to the underside of the floor using 1 3/4" x 8 woodscrews with M6 x 30 dia. washers. It is advisable to use 6 fixings per panel ensuring you avoid the moulded pipe marking on the underside of the panel and fix each panel securely.

IMPORTANT NOTE:

Polystyrene can cause deterioration to cable insulation when it comes into direct contact with it. Always ensure that electrical cables are not in physical contact with the MHP panels using tape or a polythene strip.

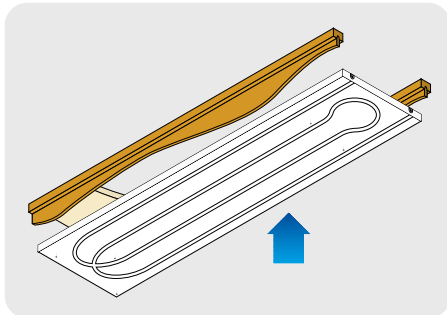

Finishing

Once you have connected your system up to the manifold and tested it, you can then finish the room by fitting the floor or ceiling in the normal way depending on whether you have installed MHP from above or below.

Testing

Where possible installations should be tested at 20°C to 18 bar pressure. Any installations once connected to the manifold have a maximum test pressure of 6 bar.

* (See page 92 for frost protection)

Panel layouts

1. Panel layout

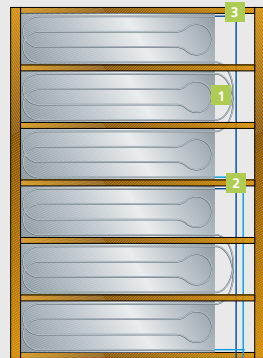

15mm Polypipe flow and return connections to manifold



Part No: PB010
10mm
Straight Coupling

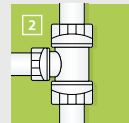

Part No: PB1115
15mm - 10mm
Reduced Branch Tee

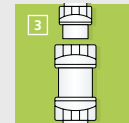

Part No: PB015
15mm
Straight Coupling
+
Part No: PB1815
15mm - 10mm
Socket Reducer

Product information	Code	No. panels per pack
MHP 490mm (W) x 2.0m (L)	MHP49020	5
MHP 490mm (W) x 1.3m (L)	MHP49013	5
MHP 380mm (W) x 2.0m (L)	MHP38020	5
MHP 380mm (W) x 1.3m (L)	MHP38013	5
MHP 330mm (W) x 2.0m (L)	MHP33020	5
MHP 330mm (W) x 1.3m (L)	MHP33013	5



System shown: Modular Heating Panel

2. Panel layout

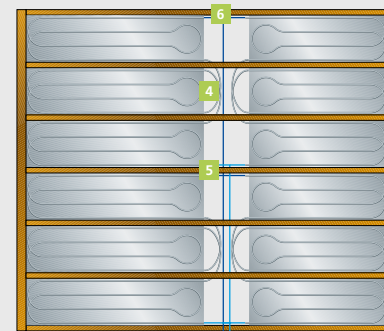

15mm Polypipe flow and return connections to manifold

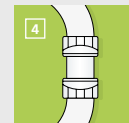

Part No: PB010
10mm
Straight Coupling

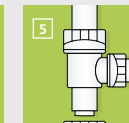

Part No: PB1115
15mm - 10mm
Reduced Branch Tee
+
Part No: PB1215
15mm - 10mm
Reduced Branch Spigot Tee

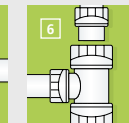

Part No: PB1115
15mm - 10mm
Reduced Branch Tee
+
Part No: PB1815
15mm - 10mm
Socket Reducer

Heat output						
Maximum floor area for flow and return 20m ²						
Room at 20°C	Flow temp. (°C)	40	45	50	55	60
	Floor temp. (°C)	25.0	25.8	26.6	28.9	30.8
Heat output per panel	MHP 49020 (W)	63	75	86	120	147
	MHP 49013 (W)	42	50	58	80	99
	MHP 38020 (W)	49	58	67	93	114
	MHP 38013 (W)	33	39	45	62	77
	MHP 49020 (W)	42	50	58	80	98
	MHP 38013 (W)	29	34	39	53	66
Approximate coverage required:						
For 70W/m ² room = 80% coverage						
For 50W/m ² room = 60% coverage						
Connect up to 3 panels in series						
Maximum coverage per circuit 20m ²						

Underfloor heating that goes over the floor

For existing solid or timber deck floors - Polypipe's unique Overlay™ underfloor heating range of low profile systems are installed over the existing floor. This makes them ideal for renovation and new build, whole house and single room projects.

Overlay™ Plus

Polypipe's new patented Overlay™ Plus underfloor heating panel is a low-profile system that has been designed to be installed over existing floors. Making it the ideal product for new build and renovation projects and direct tiling.

A version to reduce transmission of impact noise is also available with an additional layer of synthetic rubber on the underside.

Overlay™

The structural nature of traditional Overlay™ makes it ideal for direct tiling or application of floor finishes which need to be fixed or screwed to the panel.

Overlay™ Lite 15

A slightly deeper profile, which can be used on top of a supporting floor or as a low profile alternative to floating floor. The system delivers the same responsive heat but is configured to be more suitable for larger, "whole house" projects.

 Optimum performance system

Design and materials

	OVERLAY™ PLUS	OVERLAY™	OVERLAY™ LITE 15
KEY DESIGN INFORMATION			
Typical heat output at 50°C mean water temperature	Approx. 82W/m ²	Approx. 75W/m ²	Approx. 65W/m ²
Recommended design flow temperature	45-50°C	45-50°C	45-50°C
Maximum circuit length	80m (12mm pipe)	80m (12mm pipe)	100m (15mm pipe)
Maximum coverage per circuit	10m ² at 150mm pipe spacing (includes for 5 m of flow and connection lengths)	10m ² at 150mm pipe spacing (includes for 5 m of flow and connection lengths)	20m ² at 200mm pipe spacing
Dimensions	1200mm x 600mm x 18mm	800mm x 600mm x 18mm	1200mm x 800mm x 22mm
MATERIALS REQUIRED (APPROX)			
Panel coverage	Coverage 0.72m ²	Coverage 0.48m ²	Coverage 0.96m ²
End returns	2 end return per floor panel	1 end return per floor panel	0.5 x end return per panel
12mm x 80m coil of pipe	1 coil per circuit	1 coil per circuit	
15mm x 12mm adaptors & stiffeners	1 pack per circuit	1 pack per circuit	
15mm x 100m coil of pipe			1 coil per circuit

Choosing your Overlay™ floor system

OVERLAY™ PLUS & OVERLAY™		
FINISH FLOOR COVERING	FIXING METHOD	OPTIONAL INTERMEDIATE LAYER
Ceramic/Stone tiles	Direct (Ensure that the substrate is level and free from any deflection in accordance with BS8203), when fixing the tiles use a flexible tile adhesive and grout conforming to BS EN12004.	Use Polypipe Self-Levelling Compound (Product Code: UFHM13) or a suitable decoupling membrane.
Solid Timber Floor	Direct (Ensure that the substrate is level and free from any deflection in accordance with BS8203) and use a proprietary (solvent free) product in conjunction with the finish floor manufactures recommendations.	Use Polypipe Self-Levelling Compound (Product Code: UFHM13) or other suitable levelling compound.
Engineered Timber Floor	Direct (Ensure that the substrate is level and free from any deflection in accordance with BS8203) and use a proprietary (solvent free) product in conjunction with the finish floor manufactures recommendations.	Use Polypipe Self-Levelling Compound (Product Code: UFHM13) or other suitable levelling compound.
Laminate Floors	Direct (Ensure that the substrate is level and free from any deflection in accordance with BS8203), fit as a 'floating floor' in accordance with the finish floor manufactures recommendations.	Use Polypipe Self-Levelling Compound (Product Code: UFHM13) or other suitable levelling compound.
Carpet with Underlay	Ensure that the substrate is level and free from any deflection in accordance with BS8203. Use either the Polypipe Self-Levelling Compound UFHM13 or a 6mm Flooring Grade Plywood layer which can be either be glued using a suitable adhesive (solvent free) or screwed.	N/A
LVT's	Ensure that the substrate is level and free from any deflection in accordance with BS8203. Following the guidance as provided by LVT product manufacturers, a 6mm Flooring Grade Plywood layer should be applied using a suitable adhesive (solvent free) or screws and any joints in the plywood should be filled with a suitable smoothing compound.	N/A

OVERLAY™ LITE 15		
FINISH FLOOR COVERING	FIXING METHOD	OPTIONAL INTERMEDIATE LAYER
Ceramic/Stone tiles	N/A	N/A
Solid Timber Floor	N/A	N/A
Engineered Timber Floor	Direct (Ensure that the substrate is level) and install in accordance with manufactures recommendations.	N/A
Laminate Floors	Direct (Ensure that the substrate is level) and install in accordance with manufactures recommendations.	N/A
Carpet with Underlay	Ensure that the substrate is level and free from any deflection in accordance with BS8203. Use either the Polypipe Self-Levelling Compound UFHM13 or a 6mm Flooring Grade Plywood layer which can be either be glued using a suitable adhesive or screwed.	
LVT's	N/A	N/A

Overlay™ Plus and Overlay™ pre-installation requirements

Planning

Planning the Overlay™ system beforehand will save time during installation and minimise product waste.

The direction the pipe runs to and from the ZRU or manifold, and use of the return bends will be the main considerations.

The end returns have a flat panel which forms a channel to allow the routing of pipes to multiple circuits in the room. This can be removed where necessary.

Floor areas which don't require pipe circuitry, e.g. beneath kitchen cupboards or sanitaryware, can be 'blanked' using 18mm plywood or chipboard. This will make better use of the Overlay™ products. This can also be used to 'square off' rooms with irregular walls.

Example of 'blanking' on kitchen plan

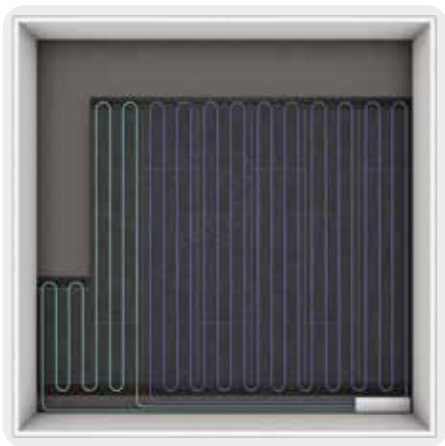

Example of 'blanking' in a bathroom



Example of 'squaring off' an irregular room plan



Room layouts

The following diagrams show some examples of room shapes, pipe requirements and interruptions (pillars, hearths, etc.) which need to be accommodated.

Room with 2 circuits

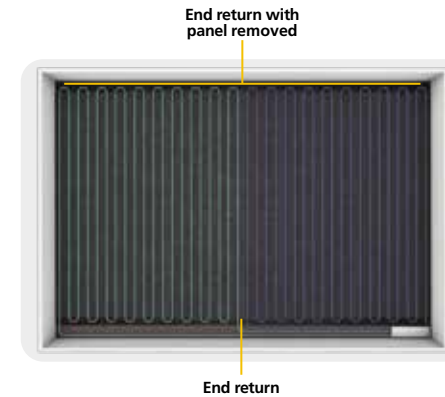

Room with pillars/hearth

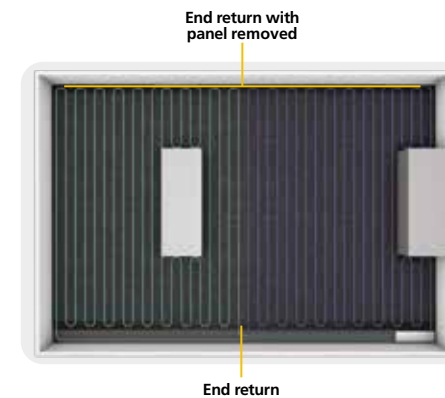

Pipe layouts in multiple room installations

Multiple room installations require several circuits and careful planning is required close to the manifold to allow for all pipes to be accommodated.

- 1 Wherever possible pipes can simply go through, rather than round, walls to eliminate the number of pipes requiring access through the entrance of the manifold cupboard
- 2 Alternatively leave voids at the edge of the panels
- 3 Using end returns as routers
- 4 Using supply pipes to heat corridors are all ways of managing the installation in this area

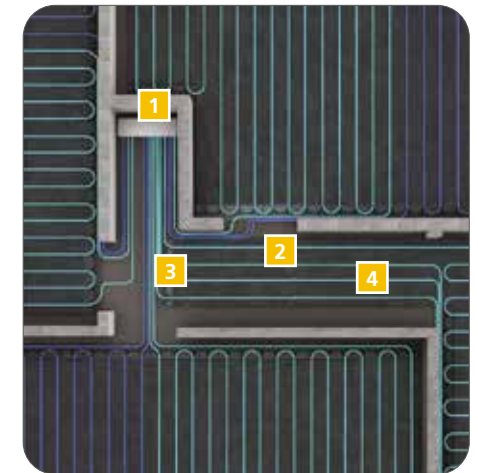

Installation - Overlay™ Plus for all floor coverings

- 1 Fits over concrete or floorboards
- 2 1200mm x 600mm x 18mm Overlay™ Plus panel
- 3 12mm polybutylene barrier pipe
- 4 End return
- 5 Suitable for tiles, hard wood floors and LVT's

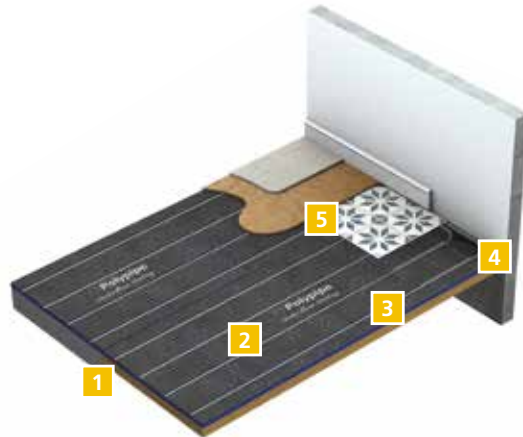

Step 1: Laying end returns

Start by fixing two end returns to the floor in a corner of the room. Remove the pipe panel if not required as per your floor plan.

This should be done by using suitable screws in the screw holes of the end return panels when fixing to a wood or solid floors.

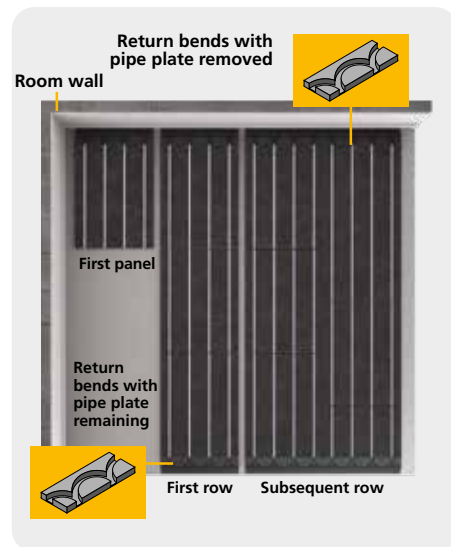

Step 2: Laying the panels

Lay the panel ensuring you line up the grooves in the panel with those in the end returns, then continue to lay the first row of panels using short lengths of pipe to help with panel alignment.

Depending on the type of substrate, the Polypipe Overlay™ Plus or Polypipe Overlay™ Plus Acoustic can be fixed with screws and washers or a continuous bed of flexible tile adhesive. It is essential that the floor onto which the panels will be fixed are flat and exhibit no movement. An uneven floor must first be made flat using a levelling compound.

For structurally sound concrete floors and most timber floors (but not traditional 'old style' wooden floorboards) screws and washers is a convenient and fast fixing method.

12 fixings per panel should be used aligned as 4 fixings down one long side (about 2cm in from the edge), another row of 4 down the middle and 4 down the other side. The fixings should comprise screws which penetrate 20mm min into the substrate and very importantly, the screws must be used with rebated washers.

The other fixing method is to lay the panels onto a thin even layer of flexible tile adhesive – this method may take a little longer and create slightly more height but does provide superior decoupling properties which is preferable on some older floors which as this system will absorb lateral expansion/contraction movement.

A notched trowel should be used to cover either the floor or the panel with an even layer of flexible tile adhesive. The panels should then be firmly pressed down and made level. Any foot traffic should be avoided until the panels are suitably bonded to the substrate.

Step 3:

When you get close to the end of the first row fit two end returns against the wall as shown in step 1 and if necessary cut an Overlay™ Plus floor panel to fit and complete the first row.



Cutting the panels

Panels can be cut using a sharp knife and a metal ruler.



Step 4:

Once you have completed the first row begin the process again with the second row, staggering the panels in a brickwork pattern.



Step 5: Laying the pipe

Starting from your manifold position and allowing enough pipe for connections, lay the pipe into the grooves of the Overlay™ Plus floor panel in accordance with your plan.



Finishing

Using a self levelling compound/adhesive, fill any gaps and voids around exposed pipework.

Tiles can be laid directly on to the Overlay™ Plus floor panels or a decoupling membrane can be fitted prior to tiling.

When tiling directly over Overlay™ Plus floor panels, use a flexible adhesive and grout.

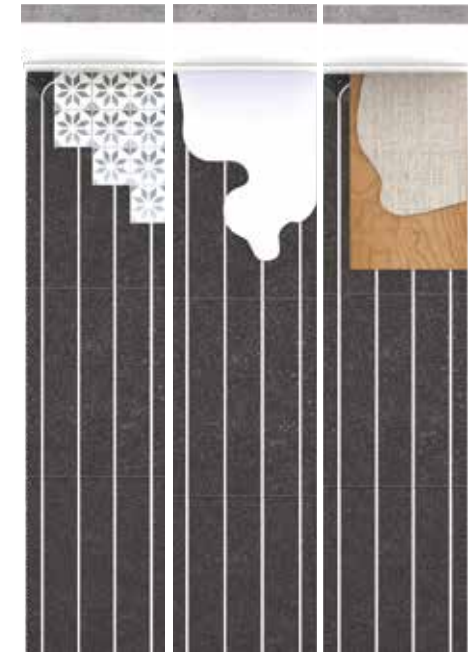

Installation - Overlay™ for heavyweight floor coverings

- 1 Fits over concrete or floorboards
- 2 Overlay panel
- 3 Pipe
- 4 End return
- 5 Suitable for tiles and hard wood floor direct

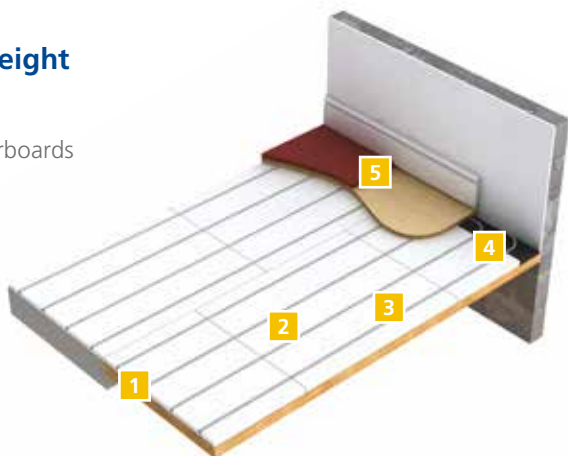

Step 1: Laying end returns

Start by fixing two end returns to the floor in a corner of the room. Remove the pipe panel if not required as per your floor plan. This should be done by using suitable screws in the screw holes of the end return panels when fixing to a wood floor, or by using Overlay™ adhesive (Product Code: PB776) to bond the end returns to solid floors.

Step 2: Laying the panels

Clean down the edges of the panel and apply a 3mm bead of adhesive to the top edge. When laying ensure you line up the grooves in the panel with those in the end returns. Continue to lay the first row of panels gluing each joint to achieve a secure installation.



When gluing the ends, ensure there is no residual glue in the pipe grooves and use short lengths of pipe to help with panel alignment.



* Refer to technical details for floor coverings on page 37.

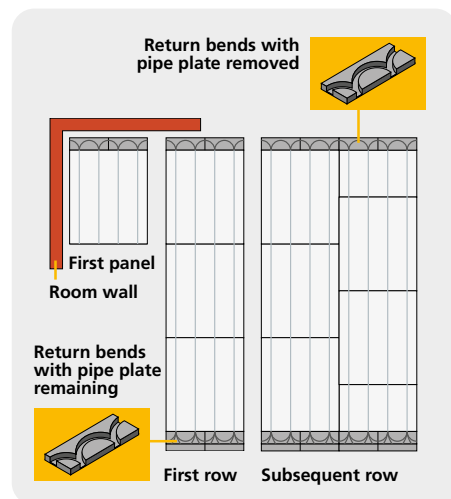

Step 3:

When you get close to the end of the first row, fit two end returns against the wall as shown in step 1 and if necessary cut an Overlay™ floor panel to fit and complete the first row.



Cutting the panels

Panels can be cut using a hand saw or jigsaw set at a low speed. Cutting these panels will generate dust so should either be done outside or in a ventilated room. Ensure you wear a particle mask.

Step 4:

Once you have completed the first row, begin the process again, gluing the ends and sides of each panel, staggering the panels in the second row in a brickwork pattern and continue until the room is complete.



Step 5: Laying the pipe

Starting from your manifold position and allowing enough pipe for connections, lay the pipe into the grooves of the Overlay™ floor panel in accordance with your plan.



Finishing

Using a floor filler/grout, fill any gaps and voids, and fill around any pipework.

Tiles can be laid directly on to the Overlay™ floor panels or a cover board can be fitted prior to tiling.

When tiling directly over Overlay™ floor panels, use a sealant with flexible adhesive and grout.

If fitting solid wood floors they can be discretely screwed through the tongue and groove directly into the Overlay™ floor panel, avoiding pipe circuitry, to minimise movement in the floor covering.

Example showing 10mm plywood cover.



Pre-installation planning and room layouts for Overlay™ Lite 15 Floor

Overlay™ Lite 15 Floor consists of system panels and end return/transition panels. Although return bends are pre-formed in the panel moulding the use of end returns for both transition pipes and around manifolds provides greater flexibility when planning pipe layouts and connection lengths.

Pipe layouts in multiple room installations

In transition areas such as hallways and corridors, a combination of end return/transition and full panels can be used in order to accommodate the pipe connection lengths and any dedicated circuit(s) for that area.

It is also acceptable to run the connection lengths at floor level alongside the edge of the panels if insufficient space is available within the panels themselves.

In the area of floor directly below and in front of the manifold the pipework can be secured in place by clipping the pipe to an Overlay™ Lite 15 floor panel laid upside down and using our pipe clips or staples.

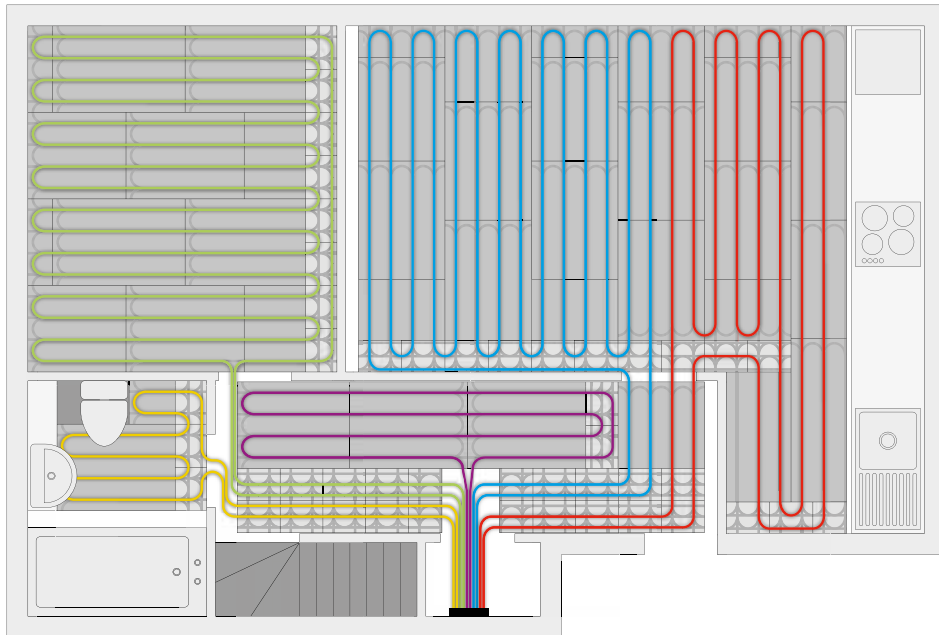

Installing multiple circuits

When a room requires two or more pipe circuits, the end return can be used to provide easy access for the connection lengths.

Step 1:

In this example the room needs two circuits so a single run of end return panels are first laid along one side of the room as shown.



Step 2:

The first section of Overlay™ Lite 15 panels can then be laid.

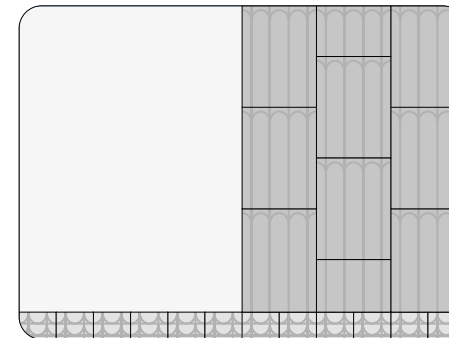

Step 3:

Once the first row of end returns are laid a second row of end returns should be laid as shown.



Step 4:

Finally the remaining section of Overlay™ Lite 15 floor panels can be laid in place to complete the installation.

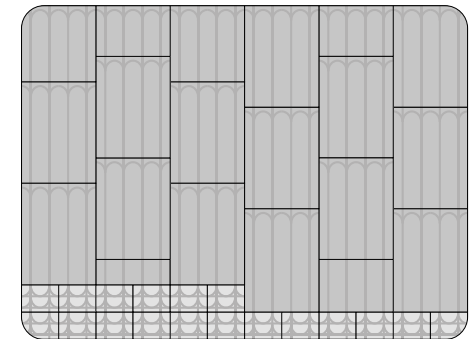

The connection lengths:

The Overlay™ Lite 15 end return panels can also be used in hallways and corridors where it becomes necessary to use these areas for circuit connection lengths.

In the example as shown below the end return panels have been used to provide both heating into the area and to convey the connection pipework to other rooms.

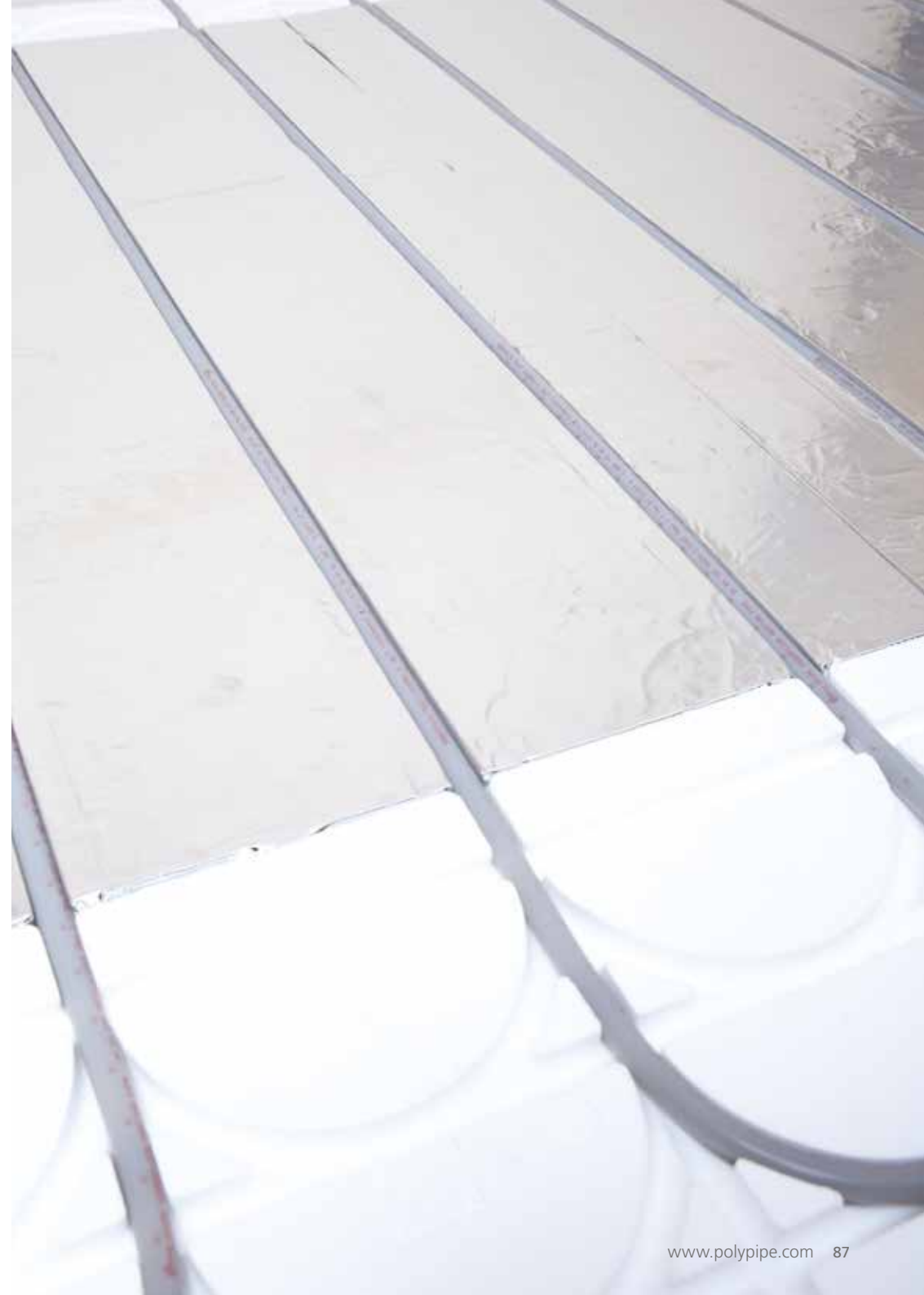
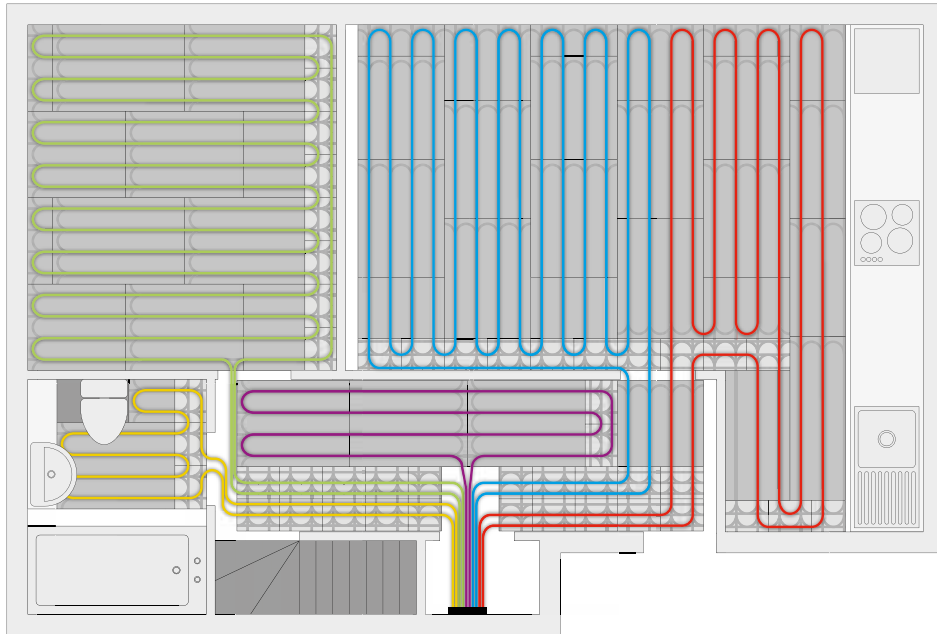

Installation - Overlay™ Lite 15 for larger floor areas

- 1 Fits over concrete or floorboards
- 2 Overlay™ Lite 15 panel
- 3 Pipe
- 4 End return
- 5 10mm plywood lining
- 6 Suitable for laminate and engineered wood floor direct



Step 1: Laying end returns

Begin by fitting a row of end return panels along one wall of the room. The end return panels should be suitably fixed down to the sub floor using screws.



Step 2: Laying the panels

Lay the first line of panels ensuring that the grooves in the end returns are aligned correctly with the grooves in the panels. Use short lengths of pipe to ensure this alignment.



Step 3:

When you reach the opposite wall, place two more end returns in place and if necessary measure and cut a panel to complete the row.

Cutting the panels

Panels can be cut using a handsaw.

Step 4:

Repeat this procedure until the floor area is complete.



Step 5:

At this point apply the self adhesive foil tape to the vertical joints in the panels to hold them securely in place.

Step 6: Laying the pipe

Starting from your manifold position and allowing enough pipe for connections, lay the pipe into the grooves of the Overlay™ Lite 15 panel in accordance with any design documentation.



Step 7

Once the pipe has been laid, complete the installation by taping up all of the remaining joints including those where the panels meet the end returns.



Finishing

Laminate and engineered wood can be laid directly over Overlay™ Lite 15 floor panels. Where carpet is being fitted, first fix a 9mm MDF using a contact adhesive, then continue to lay the floor covering as normal. It is advisable to mark out pipe positioning to avoid stapling pipes when fitting carpets.

Using Overlay™ Lite 15 as a floating floor application

[Pre-installation planning and room layouts for Overlay™ Lite 15.](#)

The Overlay™ Lite 15 system can be used as a Floating Floor application by applying a suitable layer of 18mm structural T&G chipboard directly on top of the panels.

The end return panels can be used in corridors and around doors to channel the pipe to and from the manifold.

Guide to floor coverings for underfloor heating systems

Underfloor heating systems will work efficiently with any floor covering, as long as it is well insulated underneath. However, each covering has different thermal conduction properties. Harder surfaces offer better conductivity and therefore better heat output rates. The following notes provide some guidance on each type of covering.

Carpet and underlay

Suitable for all Polypipe Underfloor Heating Systems

The nature and thickness of the carpet underlay is fundamental in determining good heat transfer. The most popular underlay type is sponge with a waffle pattern moulded into the underside. These allow good heat transfer. Felt and rubber crumb underlay should be avoided. These products can seriously reduce the effectiveness of an underfloor heating system as they insulate the floor surface and prevent heat transfer. The TOG value of carpet and underlay should be available from the respective manufacturer. For optimal system performance choose an underlay with a maximum TOG value of approximately 0.5. The maximum TOG value of carpet should be approximately 1.0 to 1.5.

Stone and ceramic tiles, marble or flagstones

Suitable for all Polypipe Underfloor Heating Systems

These types of floor finishes are usually cold underfoot. However, with underfloor heating they are transformed into warm, comfortable surfaces. Each of these finishes are essentially brittle and it is imperative that the design of the supporting floor structure is stable and rigid to prevent cracking. It is recommended that flexible adhesives and grout be used.

Vinyl

Suitable for all Polypipe Underfloor Heating Systems

Sheet vinyl is sensitive to long term exposure to heat. There are two categories of vinyl; one is limited to constant temperatures of around 26°C and the other to 30°C. Check the floor surface temperature indicated by your vinyl supplier for compatibility with underfloor heating. If unsure contact the Polypipe hotline or the vinyl floor manufacturer.

Laminate

Suitable for all Polypipe Underfloor Heating Systems

If a foam underlay layer is to be used underneath the laminate flooring, it is recommended that a product with a low thermal resistance is used. Movement that occurs must be accommodated by an expansion gap around the floor deck.

Timber

Suitable for all Polypipe Underfloor Heating systems

However, care should be taken to ensure that the moisture content of the product is less than 10%. When using a solid floor system it is essential to ensure that the screed or concrete floor has completely dried out prior to the timber floor covering being laid. It is also advisable to run the underfloor heating system for at least two weeks before the floor is laid. With natural timber products it is also advised that the flooring be allowed to acclimatise to the environmental conditions of the room before installation. When using a timber floor covering on a suspended floor construction it is vital that the intended product is classed as a 'structural' floor application. If so, this product can be laid directly on top of the joists. If this is not the case then an additional layer of 20mm/22mm timber layer will first need to be fitted and this could seriously compromise the performance of the underfloor heating system. With all timber floor applications it is important to ensure that the floor surface temperature does not exceed 27°C. Therefore care should be taken when designing the underfloor heating system to ensure that this parameter is met. Before choosing or installing your timber floor covering we would strongly recommend that you seek the guidance of the specialist timber flooring supplier/contractor to confirm the suitability of the product.



Manifolds Testing, Filling & Commissioning



Polypipe offers a broad range of manifold and water temperature controls for both traditional and underfloor heating applications.

Manifolds are used in all underfloor heating systems above 30m², irrespective of floor type. Manifolds are supplied complete and fixed with a wall mounting bracket. The manifold comes complete with a drain and air vent assembly, which can be positioned on either end of the manifold, and isolation valves are supplied separately for the supply end of the manifold.

We offer a range of 15mm push-fit manifolds for use with 12mm and 15mm pipe systems and compression manifolds for use with our 16mm and 18mm pipe systems.

Each Polypipe manifold includes a flow meter on each flow port to provide a visual indicator of the flow through rate of each circuit.

Polypipe also offers a range of water temperature control units. These are used to reduce the water temperature for underfloor heating systems, when connected to the same boiler used for radiators or stored hot water, which operate at higher temperatures than underfloor systems.

Frost protection

* Underfloor heating pipe work should not be left under test pressure when there is a potential risk of sub zero temperatures, as serious damage to the pipe can occur.

Preparing and installing the Stainless Steel manifold

Remove the manifold from the box and arrange the flow and return manifolds to ensure that the inlets/outlets are pointing downwards.

Remove the isolating valves (supplied separately) from the packaging and connect to the end of the manifold. Ensure the seal is correctly in place before tightening the compression nut by hand onto the manifold. Then, complete the connection by tightening by a further half turn using pump pliers or an adjustable wrench.

Fix the manifold horizontally in the desired position utilising both screw holes on each bracket. The manifold is now in position and ready to be connected to the mains from the boiler and the underfloor heating pipe circuits. A set of self adhesive stickers are included to help identify each circuit on the manifold (for further information on testing and commissioning see page 95).

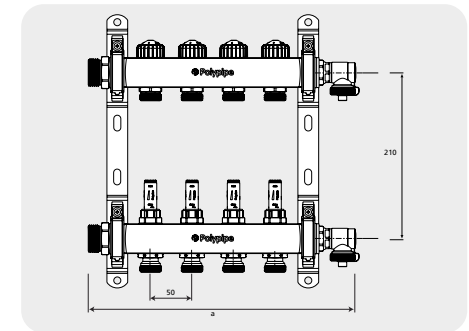

Outlets	a	Code
2	222	PB12752
3	272	PB12753
4	322	PB12754
5	372	PB12755
6	422	PB12756
7	472	PB12757
8	522	PB12758
9	572	PB12759
10	622	PB12760
11	672	PB12761
12	722	PB12762

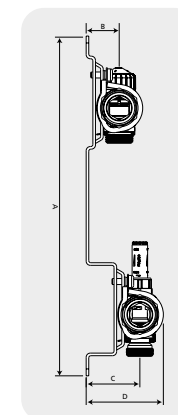

A (mm)	332
B (mm)	32
C (mm)	52
D (mm)	73



Water temperature controls

The pump pack provides temperature control and circulation for underfloor heating manifolds serving areas of up to 140m² (14Kw). The assembled pack can be installed on either side of the manifold and accurately controls supply temperatures to the manifold between 30°C and 60°C. This pump pack is fully compliant with EUP regulations and has an EEI (energy efficiency index) of less than 0.23.



Step 1:
Attach isolation valves (PB12764 supplied separately) using fibre washers to the underfloor heating flow and return ports. Optional system isolation valves are also available (PB12765), these are attached in the same way with fibre washers and have a 3/4" Male BSP thread.



Step 2:
Loosely attach one valve to the manifold using the fibre washers then swing the unit into position and connect the remaining valve, again ensuring the washers are in position, then tighten to seal.

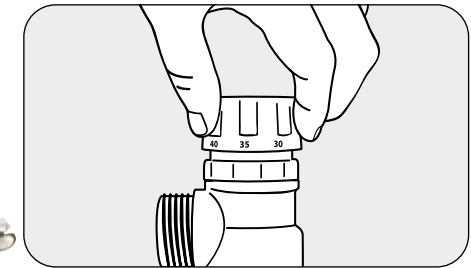
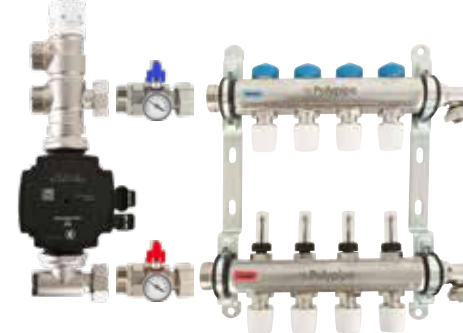

Fig.1

1. Connect the heating Flow and Return Pipes. These connections are 1" BSP Connections. Use 1" Female BSP adaptor, or System Isolation Valves PB12765.
2. Connect the 22mm Zone Valve to the Flow pipework.

Commissioning

To protect and prevent damage to the mixing control and other devices in the heating circuits, it is recommended that the pipework connecting the boiler be flushed thoroughly of flux and debris before final connection. Full bore Isolating Valves should be fitted to the primary pipework close to the mixing control for commissioning and maintenance. With the manifold isolated but filled and pressurised open the primary circuit isolating valves connecting the mixing control to the boiler and purge the primary and heating circuits by opening the manifold ball valves then vent again if necessary and finally stabilise to system design fill pressure.

Mixing Control Adjustment

The thermostatic mixing controls is factory set to provide 45°C mixed water to the heating manifold. The mixed water flow temperature can be adjusted and locked very simply to suit the design flow temperature within the range of 30-60°C. With the boiler on and the heating circuits balanced, the mixed flow temperature is easily adjusted by the unique set-and-lock clutch mechanism (Fig.1).

Reversing the pack orientation

To reverse the pack follow these steps:

1. Loosen the nut on the elbow and rotate the elbow 180° to face the opposite direction, then re-tighten
2. Remove the UFH mixer valve from the pump retaining the sealing washers
3. Using the 1.5mm allen key (supplied) loosen the exposed grub screw at the base of the mixer close to the flange connection. DO NOT remove the sticker or loosen the screw on the opposite side.

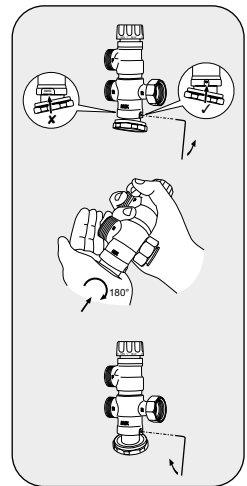

4. By putting force on the bottom of the flange and rotating this connection you can swivel the fitting 180° which should then 'click' into its new position with a clear sound, then re-tighten the grub screw
5. Re-connect the UFH mixer to the pump using the sealing washer to form a water tight seal.

Stainless Steel manifold commissioning

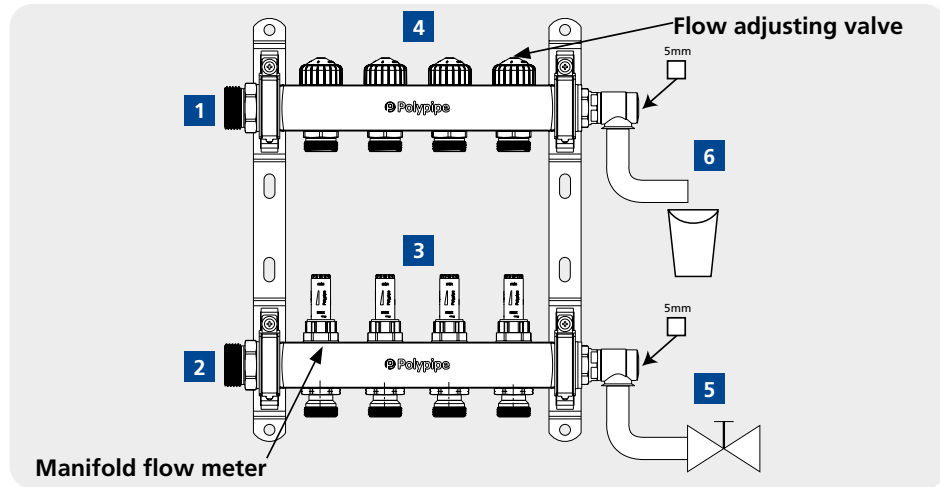

First, close the isolation valves (1&2) to the system. Then connect hose pipes to the manifold drain/ fill points.

(5) Attach the hose pipe from the bottom bar to a mains cold water supply (3 bar max) and take the other hose pipe to a drain (6).

Second, close all of the flow adjusting valves (4) by tightening the blue caps. Open all of the flow meters (3) by turning them anti-clockwise. Open both of the end filling devices (5) using a 5mm key.

Finally, going one circuit at a time, open the blue cap to start filling the loop, fill each circuit until running clear and free from air, then close the blue cap and move to the next circuit.

Once the system has been up and running for a while it will be necessary to balance the individual circuits in accordance with the design data to ensure that the correct flow rates are achieved. This should be done with system working in normal mode.

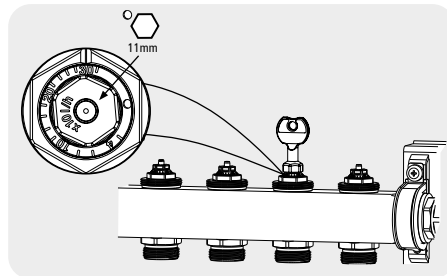

Balancing the system is simply done using the key provided, remove the blue caps and turn each circuit to the required / designed flow rate indicated in litres per hour. The Automatic flow control technology will then constantly adjust each circuit to the desired flow rate.

	-	4	-	-	10	≠	-	-	-	20	-	-	-	30	
l/h	30	40	60	80	100	120	140	160	180	200	220	240	260	280	300
l/m	0.5	0.7	1.0	1.4	1.7	2.0	2.4	2.7	3.1	3.4	3.7	4.1	4.4	4.8	5.1

Preparing and installing the Polymer manifold

Remove the manifold from the box and arrange the flow and return manifolds to ensure that the inlets/outlets are pointing downwards. Remove the air vent and drain valve from the packaging and connect to the desired end of the manifold.

Ensure the seal is correctly in place before tightening the compression nut by hand onto the manifold. To ensure the valves are securely connected to the manifold use pump pliers or an adjustable wrench and tighten by a further half turn.

Remove the isolating valves (supplied separately) from the packaging and connect to the opposite end of the manifold. As with the air vent and drain valve, ensure the seal is correctly in place before tightening the compression nut by hand onto the manifold. Then, complete the connection by tightening by a further half turn using pump pliers or an adjustable wrench.

Fix the manifold horizontally in the desired position utilising both screw holes on each bracket. The manifold is now in position and ready to be connected to the mains from the boiler and the underfloor heating pipe circuits. A set of self adhesive stickers are included to help identify each circuit on the manifold. The stickers also provide the opportunity to record the number of turns required for the correct flow rate through each circuit (for further information on testing and commissioning see page 101).

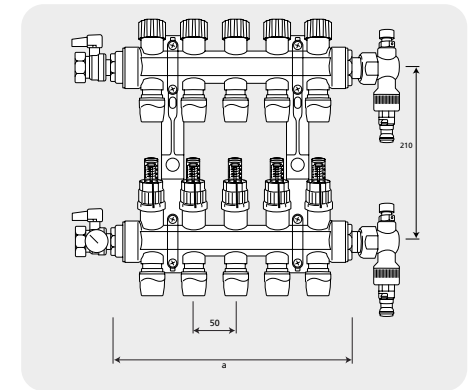

Outlets	a	Code
2	138	UFHMANP2
3	188	UFHMANP3
4	238	UFHMANP4
5	288	UFHMANP5
6	338	UFHMANP6
7	388	UFHMANP7
8	438	UFHMANP8
9	488	UFHMANP9
10	538	UFHMANP10
11	623	UFHMANP11
12	673	UFHMANP12

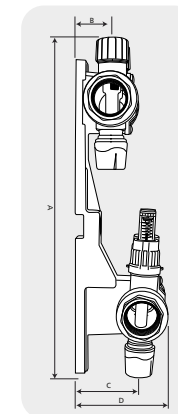

Outlets	1"
A (mm)	393
B (mm)	33
C (mm)	71
D (mm)	88



Water temperature controls

The pump pack provides temperature control and circulation for underfloor heating manifolds serving areas of up to 140m² (14Kw). The assembled pack can be installed on either side of the manifold and accurately controls supply temperatures to the manifold between 30°C and 60°C. This pump pack is fully compliant with EUP regulations and has an EEI (energy efficiency index) of less than 0.23.

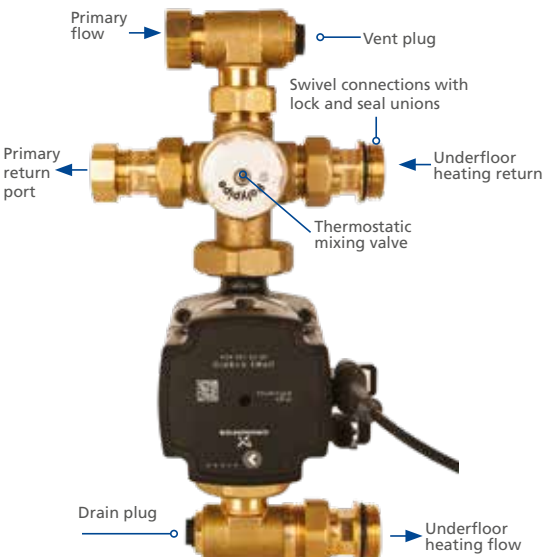

Step 1:
Attach isolation valves (UFHIVP1 supplied separately) using the rubber 'O' ring to the underfloor heating flow and return ports.



Its versatile design and 'O' ring connection system provides for simple and quick conversion on-site to Right Hand format if required.

Step 2:

Loosely attach one valve to the manifold using the rubber 'O' rings then swing the unit into position and connect the remaining valve, again ensuring the rubber 'O' rings are in position then tighten to seal.



1. Connect the heating Flow and Return Pipes.
2. Connect the 22mm Zone Valve to the Flow pipework.

Commissioning

To protect and prevent damage to the mixing control and other devices in the heating circuits, it is recommended that the pipework connecting the boiler be flushed thoroughly of flux and debris before final connection. Full bore Isolating Valves should be fitted to the primary pipework close to the mixing control for commissioning and maintenance. With the manifold isolated but filled and pressurised open the primary circuit isolating valves connecting the mixing control to the boiler and purge the primary and heating circuits by opening the manifold ball valves then vent again if necessary and finally stabilise to system design fill pressure.

Mixing Control Adjustment

The thermostatic mixing controls is factory set to provide 45°C mixed water to the heating manifold. The mixed water flow temperature can be adjusted and locked very simply to suit the design flow temperature within the range of 30-60°C. With the boiler on and the heating circuits balanced, the mixed flow temperature is easily adjusted by the unique set-and-lock clutch mechanism (Fig.1).

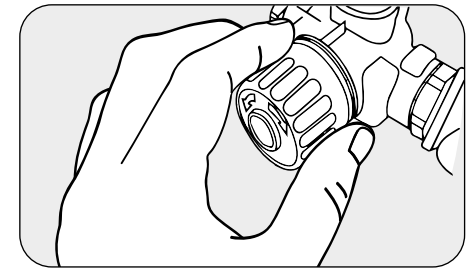

Fig.1

Minimum = 30°C							
1	2	3	4	5	6	7	8
34°C	38°C	41°C	43°C	45°C	47°C	50°C	54°C
Maximum = 60°C							

Table.1

Step 1:

Turn the dial to the required temperature as per the Table 1.

Preparing and installing the manifold

Remove the manifold from the box and arrange the flow and return manifolds to ensure that the inlets/outlets are pointing downwards. Remove the air vent and drain valve from the packaging and connect to the desired end of the manifold.

Ensure the seal is correctly in place before tightening the compression nut by hand onto the manifold. To ensure the valves are securely connected to the manifold, tighten by a further half turn using pump pliers or an adjustable wrench.

Remove the isolating valves (supplied separately) from the packaging and connect to the opposite end of the manifold. As with the air vent and drain valve, ensure the seal is correctly in place before tightening the compression nut by hand onto the manifold. Then, complete the connection by tightening by a further half turn using pump pliers or an adjustable wrench.

Fix the manifold horizontally in the desired position utilising both screw holes on each bracket. The manifold is now in position and ready to be connected to the mains from the boiler and the underfloor heating pipe circuits. A set of self adhesive stickers are included to help identify each circuit on the manifold. The stickers also provide the opportunity to record the number of turns required for the correct flow rate through each circuit (for further information on testing and commissioning see page 105).

Manifold bends (PB12735)

The water temperature control packs can be fitted at 90° to the manifold using the manifold bends. This allows manifolds and pump units to be corner mounted where space is at a premium, e.g. in an understairs cupboard.

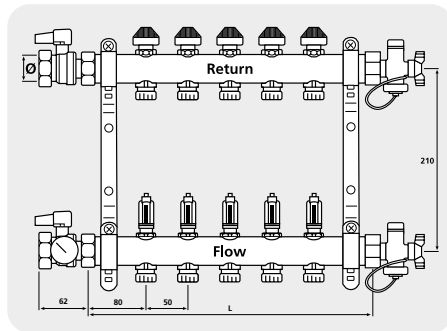

Outlets	a	Code
2	190	PB12737
3	245	PB12738
4	300	PB12739
5	355	PB12740
6	410	PB12741
7	465	PB12742
8	520	PB12743
9	575	PB12744
10	630	PB12745
11	685	PB12746
12	740	PB12747

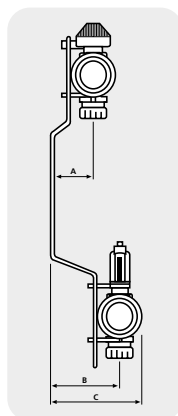

Outlets	1"
A (mm)	39
B (mm)	64
C (mm)	86



Water temperature controls

The pump pack provides temperature control and circulation for underfloor heating manifolds serving areas of up to 140m² (14Kw). The assembled pack can be installed on either side of the manifold and accurately controls supply temperatures to the manifold between 30°C and 60°C. This pump pack is fully compliant with EUP regulations and has an EEI (energy efficiency index) of less than 0.23.

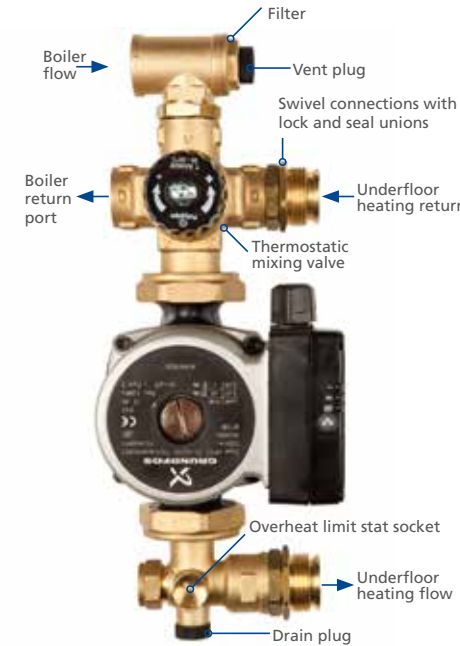

Step 2:

Attach isolation valves (PB01732 supplied separately) using fibre washers to the underfloor heating flow and return ports.



Its versatile design and 'O' ring connection system provides for simple and quick conversion on-site to Right Hand format if required.

Step 1:

- Screw the filter elbow into the blending valve until the rubber 'O' ring is touching the valve body.
- Continue to tighten the elbow for one more complete turn.
- Tighten the locking nut to complete the installation.

Step 3:

Loosely attach one valve to the manifold using the fibre washers then swing the unit into position and connect the remaining valve, again ensuring the washers are in position then tighten to seal.

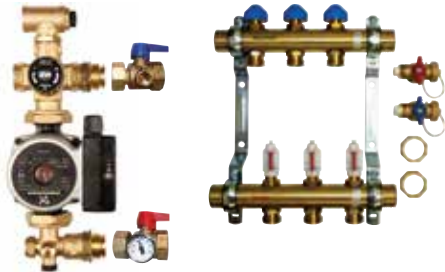

1. Connect the heating Flow and Return Pipes. These connections are 3/4" BSP Connections. Use Polyplumb PB4322 Male BSP adaptor (not included).
2. Connect the 22mm Zone Valve to the Flow pipework.

Commissioning

To protect and prevent damage to the mixing control and other devices in the heating circuits, it is recommended that the pipework connecting the boiler be flushed thoroughly of flux and debris before final connection. Full bore Isolating Valves should be fitted to the primary pipework close to the mixing control for commissioning and maintenance. With the manifold isolated but filled and pressurised open the primary circuit isolating valves connecting the mixing control to the boiler and purge the primary and heating circuits by opening the manifold ball valves then vent again if necessary and finally stabilise to system design fill pressure.

Mixing Control Adjustment

The thermostatic mixing controls is factory set to provide 45°C mixed water to the heating manifold. The mixed water flow temperature can be adjusted and locked very simply to suit the design flow temperature within the range of 30-60°C. With the boiler on and the heating circuits balanced, the mixed flow temperature is easily adjusted by the unique set-and-lock clutch mechanism (Fig.1).

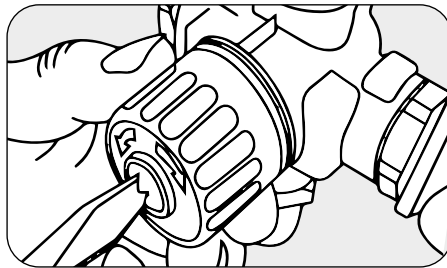

Fig.1

Minimum = 30°C							
1	2	3	4	5	6	7	8
34°C	38°C	41°C	43°C	45°C	47°C	50°C	54°C
Maximum = 60°C							

Table.1

Step 1:

Unscrew the central screw approximately ½ turn anti-clockwise to release the clutch locking mechanism.

Step 2:

Turn the knob clockwise to decrease and anti-clockwise to increase temperature.

Step 3:

The numbers on the control knob indicate the approximate mixed flow temperature when aligned with the indicator rib on the valve body (refer to Table 1).

Step 4:

Select and dial to the number required as shown in Table 1 then wait briefly for the valve to stabilise before locking the mechanism as shown in Step 5. If required, adjust the control knob accordingly until the desired flow temperature is reached and stable.

Step 5:

Tighten the central screw approximately ½ turn clockwise until hand-tight, to engage clutch mechanism and lock the temperature setting.

System balancing - Brass manifold

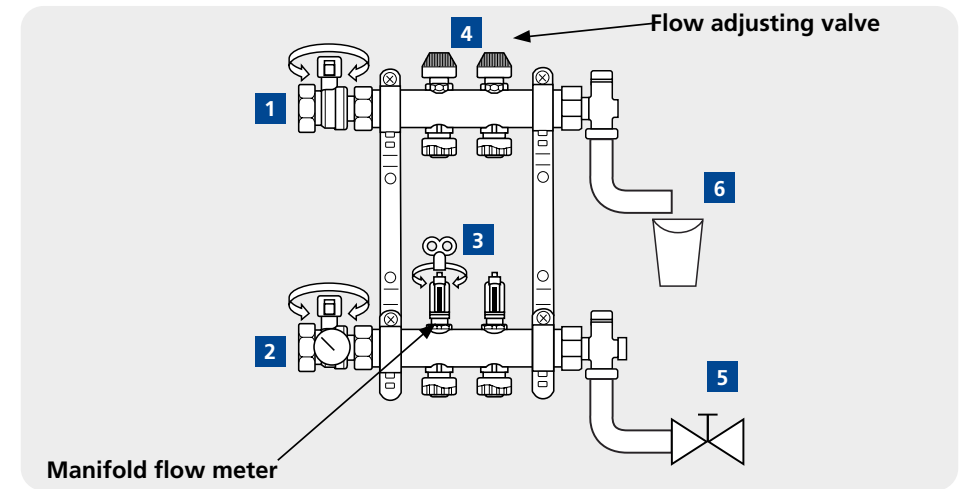

First, close the manifold isolating valves (1) and (2). Then connect a hose pipe to the manifold return drain off point (6) and take to a drain. Connect a second hose pipe to the manifold filling point (5) and attach to mains cold water supply (3 bar max). The connections to the manifold drain and fill points are ¾" BSP. Use flexible ¾" tap connectors for the simplest method of connection.

Close all of the flow adjusting valves on the return manifold rail by turning the blue caps in a clockwise direction (4). Open all of the manifold flow meters on the manifold flow rail by turning (3) them in an anti-clockwise direction using a radiator vent key. Open the first circuit on the manifold by turning the blue cap anti-clockwise and then open the drain and fill points (5) and (6). Using the mains cold water supply, flush out and fill the first circuit.

Once this circuit is running clear and free from air, open the second circuit on the manifold and repeat the process until all of the circuits are fully opened and purged of air. Close the drain and fill points.

IMPORTANT NOTE:

All of the manifold flow meters must be fully opened prior to flushing and filling the manifold circuits.

System balancing - Brass manifold

Once the system is up and running it is necessary to balance the system in accordance with the design data provided. This should be done using the following method:

Ensure that the boiler and main system duty pump are operating correctly and that sufficient heat input and flow rates are being provided at the manifold(s). Set the underfloor heating controls to call for heat and check to see that the two-port zone valve and manifold pump are energised.

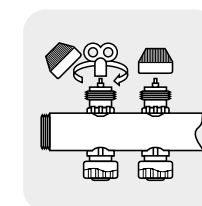

Remove the blue cap from the manifold return port and, using the bleed key provided, turn the flow adjustment spindle clockwise to completely close the circuit.

Slowly open the valve by turning the spindle anti-clockwise until the required flow rate in l/min is achieved in the flow meter window.

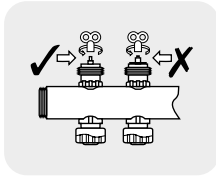

NOTE:

The isolating valve fitted to the manifold flow meter is not used for balancing purposes.

If it becomes necessary to close off a manifold completely, this can be done by using a 3/4" brass cap with a suitable rubber washer insert.

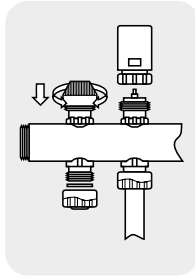

Once all of the circuit flow rates have been adjusted, the system should be left to operate for a short period whilst any remaining air is removed.

Once this has been done, the flow rates should be re-checked and adjusted if necessary before the actuator heads are fitted. If the actuator heads are not likely to be fitted for a while then it is recommended that the blue caps are used in order to protect the flow rate settings and prevent any debris from entering the flow valve assembly.

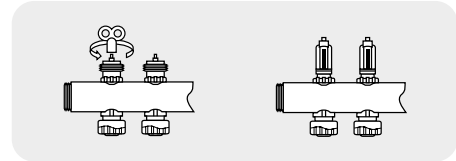

When adjusting the manifold flow rates, care should be taken to ensure that the adjustment spindle is not left with any of the thread showing.

In order to carry out any maintenance to the installation it is possible to isolate individual circuits by closing both the flow and return ports, as shown in the diagram below.

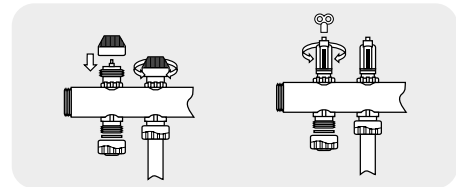

Introducing...

the Single Zone Electric Boiler for Underfloor Heating

The Single Zone Electric Boiler means that underfloor heating can now be installed as a standalone system – removing the need to plumb into the existing heating system.

This is ideal for compact projects, such as lodges, cabins and garden rooms. It is also a solution for self-contained extension or conversion projects where it is undesirable to plumb in to the house's existing heating system, making adding underfloor heating to kitchens, conservatories and lofts even simpler.



This sleek, white, compact unit can supply hot water to service underfloor heating in areas up to 38m².*

Included within the boiler is all the required components for plumbing in your Polypipe Underfloor Heating system:

- 3kw heating element
- 2 port push fit manifold
- Pump
- Expansion
- Pressure relief
- Pressure gauge
- Filling connections
- Air vent

Quick and easy installation:

- Simple wiring to standard 13amp connection
- Simple push fit pipe connections
- Temperature range from 24° to 56° - ideal for UFH
- Inbuilt RF receiver easily paired to RF Programmable Thermostat (included)

* Based on a requirement of 80w/m². For help specifying your system, contact our Design Engineers via design@polypipe.com

Room Temperature Controls



An extensive range of Polypipe Room Temperature Controls are available to complement each Polypipe Underfloor Heating system. They are designed to be easy to use – and easy to install – whilst maximising the comfort and efficiency of the occupant's home.

The complete controls range is available in four different options, Simple, Standard, Smart and Smart Plus and can be installed in both Hard Wired and Radio Frequency (RF) options.

The traditional range is comprised of Simple and Standard control options which can be selected according to the user's needs.

The recently introduced Smart range offers three different control options, Simple (dial thermostat), Standard (programmable thermostat) and Smart (internet enabled). This new range has been designed to be slim and stylish and feature proximity based illuminated soft touch keys.

The Smart Plus range of room temperature controls have an easy to use touchscreen interface and also enables homeowners to control their heating away from home using their phone, computer or tablet.

The full range of Polypipe Room Temperature Controls allows occupants to get the best out of their Polypipe Underfloor Heating system, giving users the flexibility to programme their settings to their precise needs and lifestyle.

Controlling underfloor heating

Whilst all of our control options can be used with any of our underfloor heating systems, our expert design team will make recommendations based on floor type, use of space, type of project and the user or occupant.

All of our controls allow individual room temperature control as a minimum, with our programmable controls providing independent time and temperature control of each room.

Time and temperature control of each room

Standard Programmable & Smart Room Thermostats

This control method uses Standard Programmable and Smart Plus Room Thermostats and allows each room to be individually programmed. This ensures rooms are heated to the level required, when required. What's more, each room can be programmed differently for each day of the week, so the room is only heated when occupied. This option is available in both Hard Wired and RF ranges. This control method also provides "optimum start" and "setback" functions.



- Optimum start – This function allows the thermostat to learn the heat-up profile of each room individually. This allows the user to set a 'warm by' time rather than an 'on' time, meaning that each room reaches the perfect temperature, at the required time, in the most efficient way possible.
- Setback – This ensures, that when the room is unoccupied, it maintains a minimum temperature preset by the user. This is important when using high mass systems such as the Polypipe Solid Floor System. The response time of the system is slower than that of other Polypipe systems and we therefore recommend that a setback temperature is used to reduce the time needed to bring a room up to the desired temperature when required. Please note that operating underfloor heating with a setback temperature is still more energy efficient than a radiator system.



Time Clocks and Simple Dial Thermostats

This method allows the user to set the on/off time for all rooms served by a single manifold and provides individual room temperature control. This option is most suited for low mass systems that have a quicker response time e.g. Overlay™, where setback is not required.

The room temperature control is a Simple hard wired dial thermostat and used in conjunction with a time clock.

Control Operation

In all cases the control set-up will consist of either a four or eight zone master wiring centre (for multiple room control) and individual room thermostats.

When a demand for heat is sensed, the master wiring centre will open the relevant manifold actuators, open the two port zone valve, switch the underfloor heating pump and generate a boiler enable signal.

Building regulations requirements

In order to comply with the room temperature control requirements for domestic buildings under the Buildings Regulations (Part L), the following should be adhered to as a minimum.

NOTE:

This applies to installations connected to both domestic gas boilers and heat pumps.

- Each room should be provided with its own Simple dial or Standard programmable thermostat. Where 2 rooms have a similar function e.g. kitchen and utility room, it may be possible to use one thermostat to control both rooms.
- In single storey open plan dwellings where the living area is greater than 70% of the total area, individual room controls are not required.
- Standard and Smart Plus programmable controls with setback functionality are recommended where solid floor screeds are thicker than 65mm.

Polypipe Smart Plus range of room temperature controls

Introducing our extensive range of premium controls featuring touchscreen technology, simple installation and optional internet connectivity.

The Smart Plus range is Polypipe's most technologically advanced yet. It includes various zone control options which can be mixed and matched around the home to give flexible functionality where required. The TFT Master Touchscreen thermostat can control up to eight zones and override pre-set temperatures and schedules. The range uses RF communication technology and includes both mains and battery powered room thermostats. All of the Smart Plus range can be controlled remotely by the customer using their smartphone, tablet or computer.

Choose a system in 3 simple steps

We have put together a 3 step journey for you and your customers to see how each of our controls can be easily combined to create a system that's right for every project.

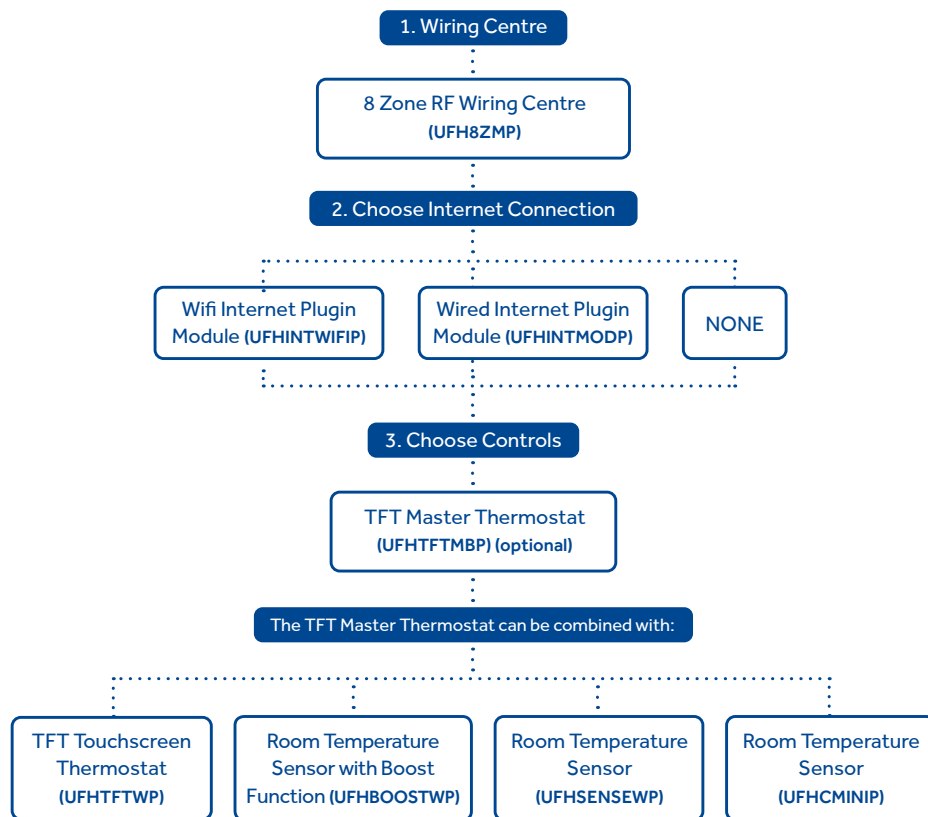

1. Wiring centres

8 Zone RF Wiring Centre with Display (UFH8ZMP)

The wiring centre is required when using any of our Smart Plus controls and allows you to register the controls at the touch of a button. It is designed to manage up to 8 zones and comes with a screen display for an easy step-by-step set up.

Pairing your customer's underfloor heating system with the new 8 Zone Wiring Centre will help them save significantly on their energy bills as the controller precisely manages the temperature of each room.

For more information on wiring centres see page 114.



2. Choose internet connection

Your customers have the option to choose a wireless or wired internet connection for their system.

A. Wifi Internet Plugin Module (UFHINTWIFIP)



Installed, near the manifold, this wall mounted device allows wireless connection to the broadband router, allowing system owners to view statistics and make changes to the preset temperature log and schedules. Allow one module per manifold to be controlled.

B. Wired Internet Plugin Module (UFHINTMODP)



This unit requires wired connection to the broadband router and the wiring centre to enable remote control over the system's operation. Allow one module per manifold to be controlled.

3. Choose controls

Master Room:



TFT Master Thermostat (UFHTFTMBP)

This large, easy-to-read, touchscreen thermostat is the main device your customers will need to control their underfloor heating system and has a variety of frame colour options to choose from. Users can control up to 8 zones from the thermostat and when used with the Internet Plugin Module, the unit is compatible with your customer's smartphone, tablet or computer.

Other Rooms:



TFT Touchscreen Thermostat (UFHTFTWP)

This touchscreen thermostat works with the Master thermostat and is fitted in other rooms in the house. The control allows users to adjust the pre-set room temperature and daily schedule in a specific room or zone. What's more, they have the option to use pin-protected security to prevent unwelcome changes.

Room Temperature Sensor with Boost Function (UFHBOOSTWP)



Although room temperature is primarily operated through the Master Thermostat, the boost function allows users

to temporarily boost the temperature for the designated zone – making it ideal to control temperature in spaces such as bedrooms. The sensor also smartly decides whether to turn the system on or off to achieve the pre-set Master Thermostat programme, depending on the current room temperature.

Room Temperature Sensor (UFHSENSEWP)



This sleek looking temperature sensor is operated through the Master Thermostat. It's minimalistic and battery powered,

making it ideal for wet rooms and bathrooms.

Other Rooms:



Single Zone Mini Sensor (UFHCMINIP)

The UFHCMINIP sensor is designed to operate with the main smart plus control unit.

The sensor should be installed in a suitable position within the relevant heating zone and will provide the main control unit with the current room temperature reading.



Single Zone Floor Sensor (UFHFLRWP)

The UFHFLRWP is designed to provide floor surface temperature limitation.

The thermistor sensor should be installed at the floor interface between the Underfloor Heating system and the finished floor covering.

The sensor can be programmed to provide and high and low floor temperature setting.

This is essential where either timber or vinyl flooring products are being used.



Wired Internet Plugin Module with Control 4 connectivity (UFHC4MODP)

The new UFHC4MODP module is designed specifically to

integrate your Underfloor heating system into a Control 4 Home Automation package. Giving you a number of choices to access and control your Underfloor Heating remotely via apps.



Remote Boiler Switch (UFHRBSP)

Allows wireless boiler communication once it is paired to up to 4 master wiring centres UFH8ZMP. The built in volt free relay can be used with boilers that require either a single 'live in' or a 'live in and live out' connection and is also suitable for use with extra low voltage switching (24v).



Single Zone Radiator Actuator (UFHTRVP)

Designed to replace a standard TRV head, the UFHTRVP actuators can be paired to a single room thermostat to control up to a maximum of six

radiators within that zone/room. The RF communication enables the user to remotely maintain accurate room temperatures and comfort levels.



Wiring centres

8 Zone RF Wiring Centre with Display (UFH8ZMP)

The Wiring Centre can control up to 8 zones at the push of a button and allows operation of actuators, a zone valve, the underfloor heating pump and boiler signal. There are three power ports with each one capable of powering up to two thermostats.

For all thermostats the pairing process is initiated at the wiring centre, with each step showing on the display. The system assists with the wireless control of the valves which results in significant energy saving due to precise temperature management in particular rooms.

This gives users the flexibility to activate and check if particular devices such as the pump, voltage free contact and the valve actuators work properly and are maintained irrespectively of each other.

As an installer, you are able to provide your customers with an underfloor heating system that is cost effective, energy efficient and is from an easy-to-use control.

The main features of the wiring centre allow users to check on the working status of particular devices and also decide if a given zone needs to be heated on the basis of the current temperature and regardless of whether the system is programmed to turn on during the day.

Initial Pairing

For all thermostats the pairing process is initiated at the wiring centre.

- Press the menu button and then scroll down to the zones
- Press the menu button and scroll to the zone number that you wish to pair a control to
- Press the menu button and scroll down to Registration
- Press the menu button, the display should now read 'Sensor'
- Press the menu button, the display should now read 'Registration Press EXIT'

The zone is now ready for pairing.

For a step by step instructional video, visit www.training.polypipe.com/pairing

TFT Master Thermostat and TFT Touchscreen Thermostat

Complete pairing by:

- Press the menu button on the thermostat screen
- Press the 'Controller Settings' icon
- Press the 'Registration' icon

Once paired, the wiring centre screen should read 'Module Registered Press EXIT'. You can then move on to the next room.

Room Sensors (not including Single Zone Floor Sensor)

Complete pairing by pressing the small button on the back of the sensor. The wiring centre screen will now say 'Module Registered Press EXIT'. Press Exit to complete pairing.

Single Zone Floor Sensor

First pair any room sensor to the zone, then pair the Floor Sensor to the same zone following the below steps:

- Press the menu button and then scroll down to zones
- Select the zone required 1-8.
- Select floor heating, then Floor Sensor, then registration
- Press the button on the back of the unit.

NB. Only one thermostat or sensor can be paired to each room. If you pair a new thermostat to a room with an existing thermostat, it will overwrite the pairing and remove the previous thermostat.

Radiator and domestic hot water control

The UFH8ZMP can also be used to control both a radiator and a domestic hot water zone if required. A radiator circuit can be added by using any of the zones 1 - 8 in the master wiring centre.

The domestic hot water circuit must always be assigned to zone 8 in the master wiring centre.

By using the settings in the installer menu, both of these zones can be used independently of the underfloor heating.

- Press the menu button and then scroll down to the installer menu
- Press the menu button and scroll to choose either the radiator or domestic hot water (DHW), then press the menu button and enable your selection
- A radiator icon will appear in the zone allocated to the radiator circuit and a hot water cylinder icon will appear in zone 8.

Typical installation with zone valve

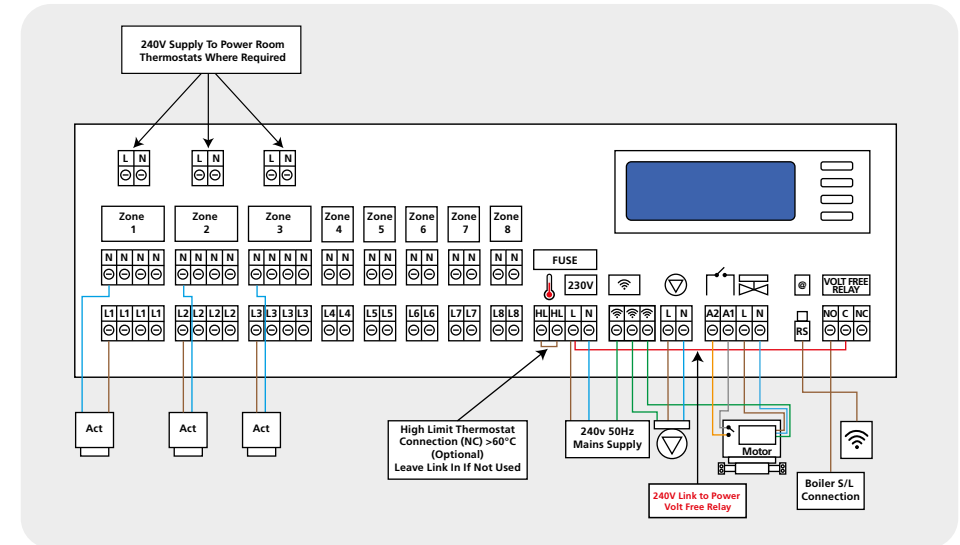

If fitting without a Zone Valve, ensure that the factory fitted link across terminals A1 and A2 is in place.

Additional wiring requirements when using radiator and domestic hot water zones

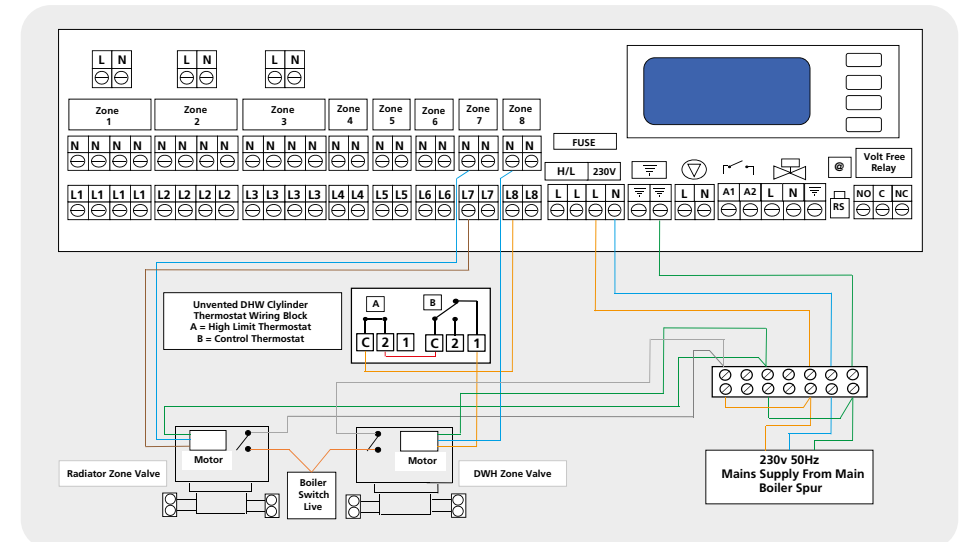

Polypipe room temperature controls selection

All control options provide temperature control to each room as required, a summary of the options is shown below.

CONTROL TYPE	SYSTEM CONTROL		DISPLAY/ OPERATION			CONNECTIVITY	
	PER ROOM	PER MANIFOLD	DIGITAL	DIAL	TOUCH SCREEN	WIRED	WIRELESS RF CONTROL VIA INTERNET*
Simple Dial Wired Thermostats	☑			☑		☑	
Time Control 4 Channel Time Clock		☑			☑	☑	
Standard Programmable Wired Thermostats	☑		☑			☑	
Smart Programmable Wired Thermostats	☑		☑			☑	☑
Smart RF Programmable RF Thermostats	☑		☑				☑

* Wireless connectivity available via Smart Hub UFHWIFIHUBW

Traditional Controls Range Room Thermostats

Standard Programmable Room Thermostats (UFHPROGW)

Programmable room thermostats offer the following outstanding features:

- User Modes (5/2 day, 7 day, 24 hour and none programmable (room temperature sensor mode only))
- Setback and optimum start functionality
- Frost protection technology
- Holiday standby mode
- Simple user defined programming
- Wet room sensor connection
- Temperature hold feature
- Floor temperature limitation



Smart Programmable Room Thermostats (UFHSMARTW) & (UFHSMARTRFW)

Smart and Smart RF programmable room thermostats offer the following outstanding features:

- User Modes (5/2 day, 7 day, 24 hour and none programmable (room temperature sensor mode only))
- Setback and optimum start functionality
- Frost protection technology
- Holiday standby mode
- Simple user defined programming
- Floor sensor and air sensor connection
- Temperature hold feature
- Floor temperature limitation
- Mesh networking
- Internet connectivity when used with the Smart Hub
- Statistics chart



Time Clocks – 4 Channel Time Clock (UFHTIME4W)

The digital time clocks are used in conjunction with dial thermostats. The time clocks offer the following features:

- User Modes (5/2 day, 7 day)
- Boost functionality
- Copy function
- Holiday standby mode
- Simple user defined programming
- Mode selection (Auto, Off & Constant)
- Global functions
- Statistics chart



Simple Dial Room Thermostat (UFHDIALW)

This simple dial type room thermostat combines accurate comfort control with a familiar dial type user operation.



This thermostat is used in conjunction with the time clock (UFHTIME4W).

Wiring centres

Four Zone Wiring Centre (UFH4ZW)

The UFH4ZW can be used in conjunction with our main thermostats. The UFH4ZW provides central switching for up to four zone actuators, as well as providing an output for hot water cylinder, the system boiler and pump.



These wiring centres allow connection of:

- Heating main supply, UFH pump, zone valve and boiler enable
- Volt free boiler switching connection
- Optional connection for domestic hot water zone

Eight Zone Wiring Centre (UFH8ZW)

The UFH8ZW can be used in conjunction with our main thermostats. The UFH8ZW provides central switching for up to eight zones actuators, as well as providing an output for hot water cylinder, the system boiler and pump.



These wiring centres allow connection of:

- Heating main supply, UFH pump, zone valve, boiler enable and time clock
- Option to add domestic hot water zone
- Volt free boiler switching connection
- Optional connection for radiator valve
- 230v actuators
- Output indication

Eight Zone RF Wiring Centre (UFH8ZRFW)

The UFH8ZRFW can be used in conjunction with our wireless thermostats. The UFH8ZRFW provides central switching and is their ideally situated next to the underfloor heating manifold. Eight zones can be controlled as well as providing an output for hot water cylinder. On demand from any zone, a 230v output is provided to switch the relevant zone actuators, underfloor heating pump and valve. A volt free connection is supplied for the boiler, making it compatible with almost all types of boilers. Up to six actuators can be connected to each zone. A software option in our wireless thermostats allow you to configure which zones and underfloor heating and which are radiators. The UFHBSW can be paired to the UFH8ZRFW in order to offer a wireless boiler link.



These wiring centres allow connection of:

- Heating main supply, UFH pump, zone valve, boiler enable
- Option to add domestic hot water zone
- Volt free boiler switching connection
- Optional connection for radiator valve
- 230v actuators
- Output indication
- Pump delay enable

Ancillary items

Floor Sensors (UFHFLOORW)*

The 2.95m remote sensor probe can be used with all of our thermostats that accept a remote sensor. It can be used to measure air or floor temperature and is specifically designed to be used as a floor sensor.



Sensor Box (UFHSBOXW)*

The Sensor Box has been designed to house the Remote Sensor Probe where underfloor heating is to be installed into wet rooms. The sensor box allows the probe to measure the ambient air temperature within the room.



* these two products used in conjunction with each other create a single wet room sensor.

Thimble Sensor (UFHTHIMW)

The Thimble Sensor is perfect for providing discreet room temperature measurement where the client does not want to use a wall mounted room thermostat. The UFHTHIMW can be used with all of our thermostats that accept a room sensor and can be positioned up to 20 metres away.



Smart Plug (UFHSPLUGW)

The Smart Plug acts as a wireless repeater for the RF thermostat range and is designed to extend the wireless communication distance around your home. It can also be used to control an appliance remotely via the app. The Smart Plug also incorporates Geo Location functionality.



SmartHub (UFHWIFIHUBW)

The SmartHub handles all of the online network communication between the SmartStat (UFHSMARTW), SmartRF Room Thermostat (UFHSMARTRFW) and the Smart Plug (UFHSPLUGW) enabling you to control up to 32 individual hot water, heating zones or appliances. The SmartHub brings Apple HomeKit, Google Home and Amazon Alexa support to your home network when connected to your broadband router.



Other SmartHub features include:

- Mesh networking
- Cloud server connection
- Remote updates

RF Boiler Switch (UFHBSW)

The RF Boiler Switch is a heating and hot water cylinder wireless thermostat receiver. It can cater for a single heating zone and hot water cylinder as well as providing a boiler enable output. Output indications are provided and the unit is surface mounted for easy installation. In addition, the RF Boiler Switch can act as a wireless boiler enable link from the UFH8ZRFW.



Wiring centres - for wired controls

4 zone wiring centre (UFH4ZW)

The 4 zone wiring centre (UFH4ZW) can be used with the range of Smart thermostats, Simple (UFHDIALW), Standard (UFHPROGW) and Smart (UFHSMARTW) to control up to 4 heating zones. If required an option to add a radiator and domestic hot water zone is also available.

Wiring detail for 4 underfloor heating zones using UFHSMARTW thermostats.

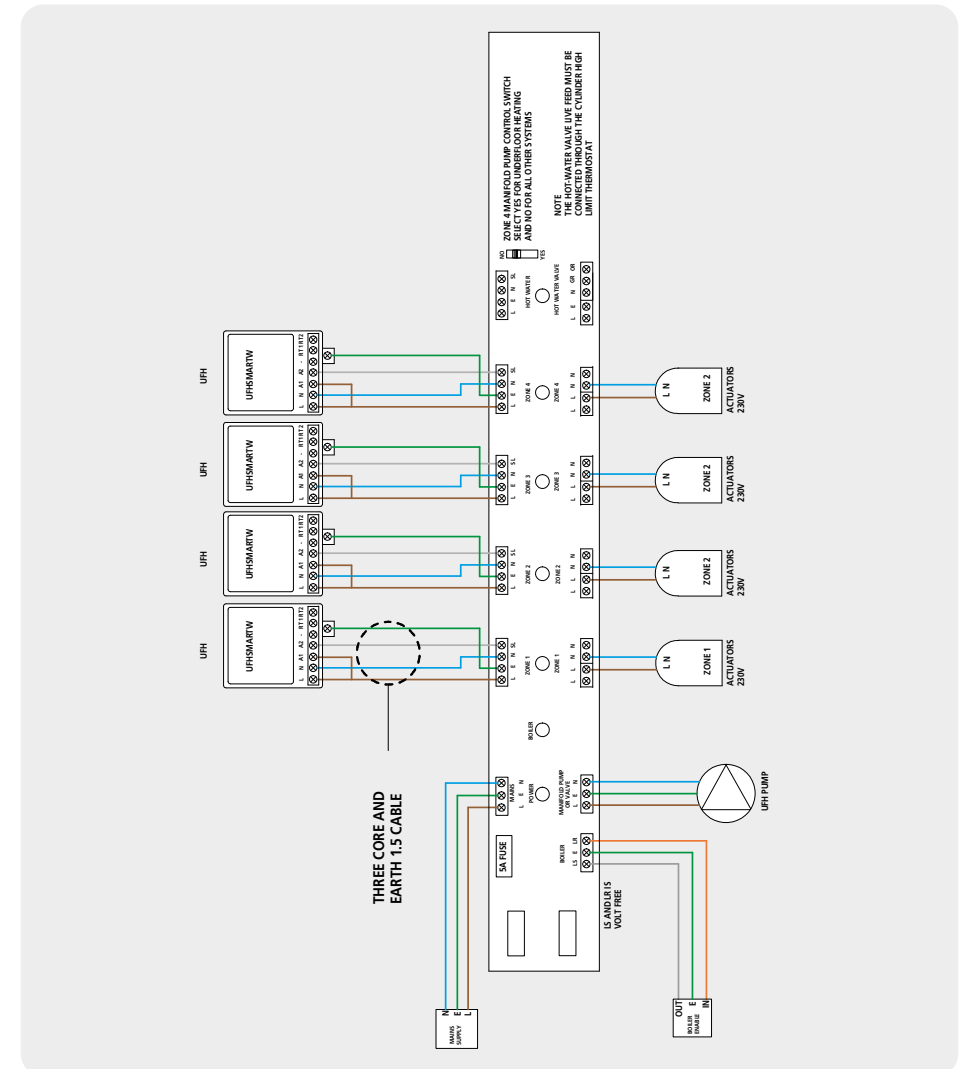

4 zone wiring centre (UFH4ZW)

Wiring detail for 3 underfloor heating zones and 1 radiator zone using UFHDIALW thermostats and UFHTIME4W timer.

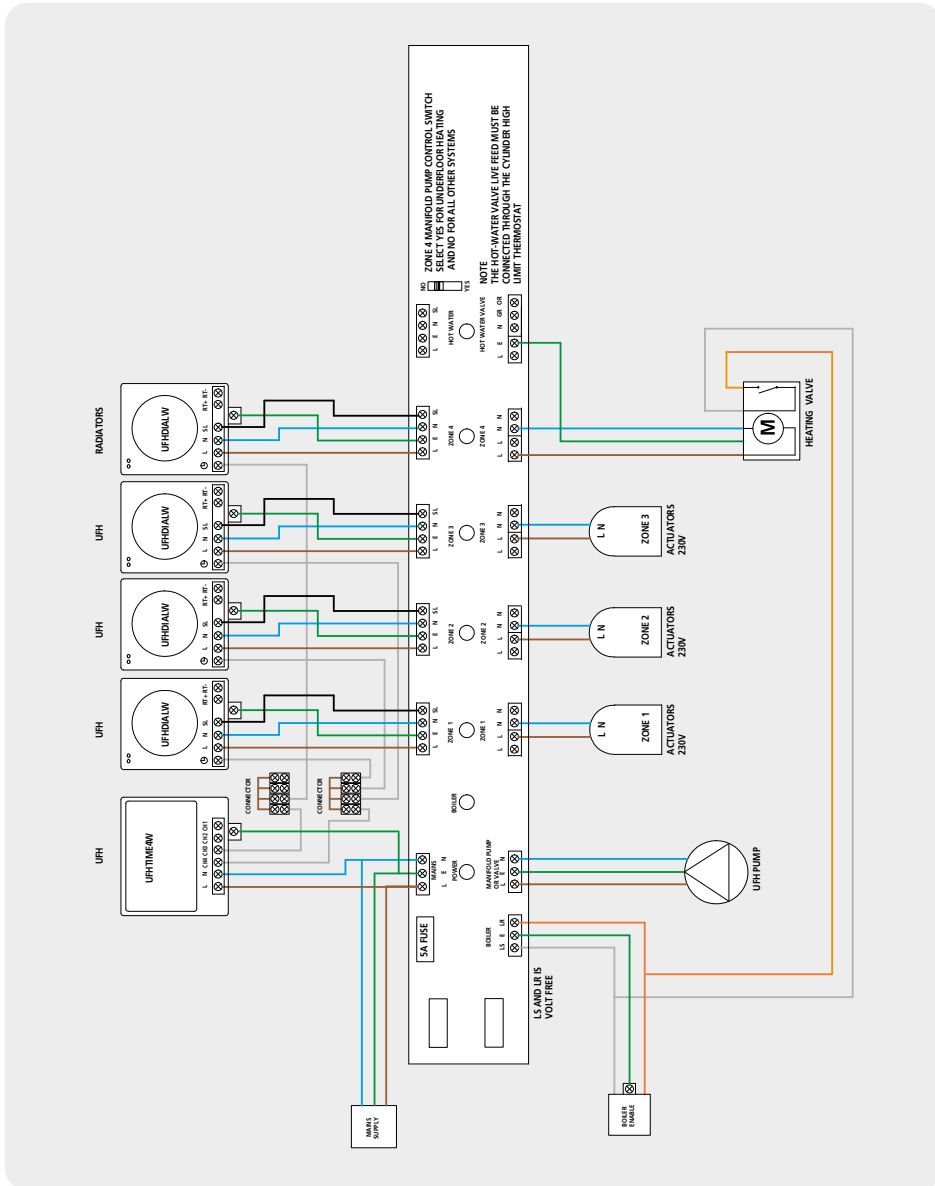

4 zone wiring centre (UFH4ZW)

Wiring details for 3 underfloor heating zones, 1 radiator zone and 1 DHW zone using UFHTIME4W four channel timer.

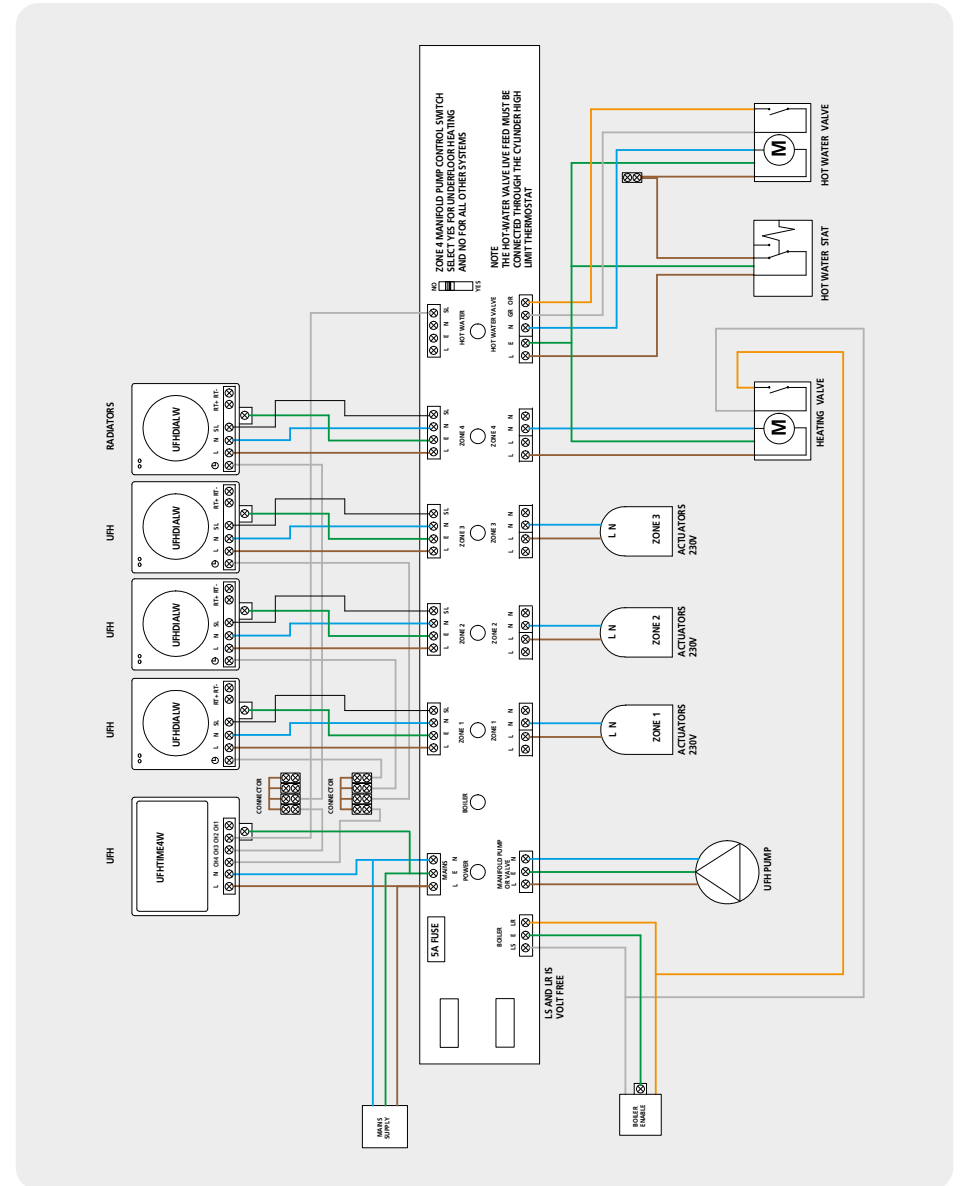

4 Zone Wiring Centre (UFH4ZW)

Wiring for 3 underfloor heating zones with 2 Port Motorised Zone Valve.

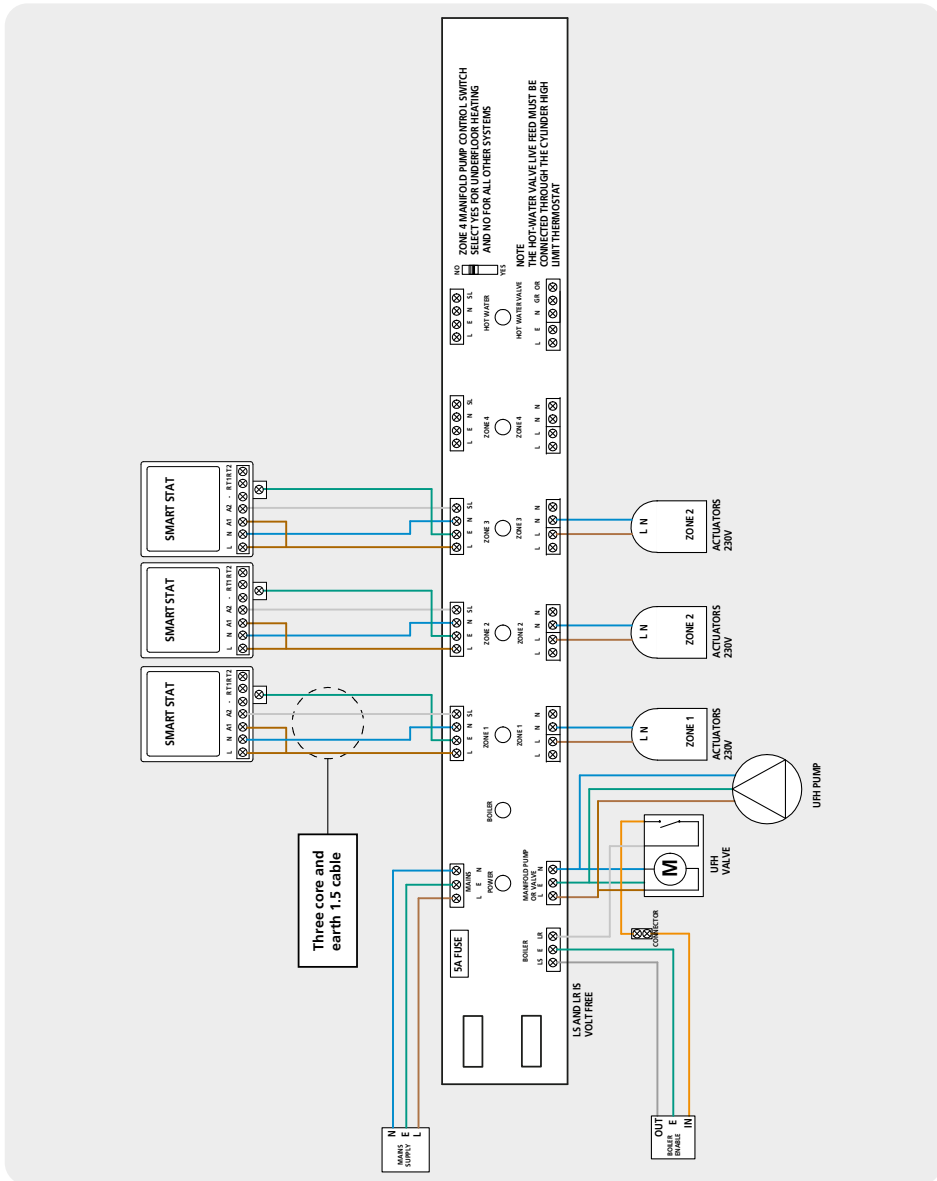

Wiring centres - for wired controls

8 zone wiring centre (UFH8ZW)

The 8 zone wiring centre (UFH8ZRFW) can be used with the Smart thermostat (UFHSMARTRFW) to control up to 8 heating zones. If required an option to add a radiator and domestic hot water zone is also available.

Wiring details for 8 underfloor heating zones using UFHSMARTW thermostats.

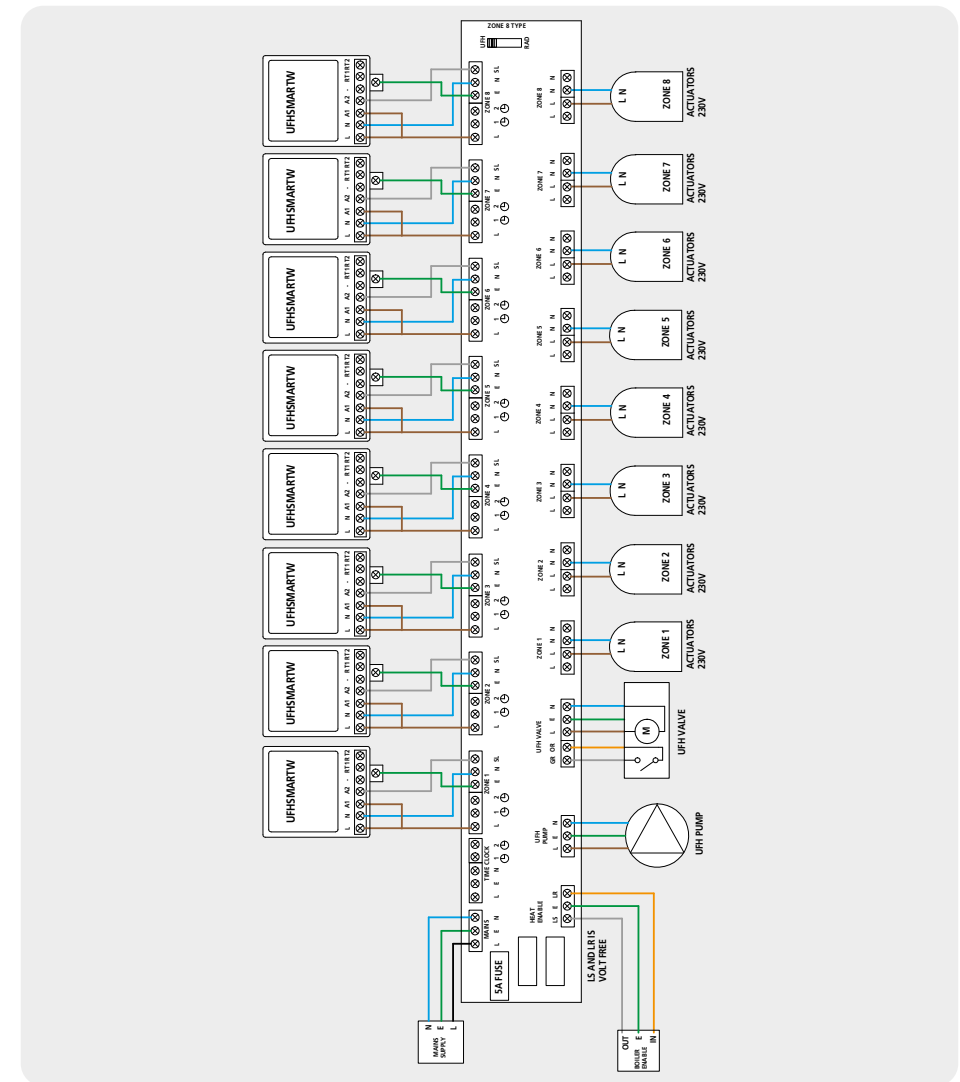

8 zone wiring centre (UFH8ZW)

Wiring detail for 7 underfloor heating zones and 1 radiator zone using UFHPROGW thermostats.

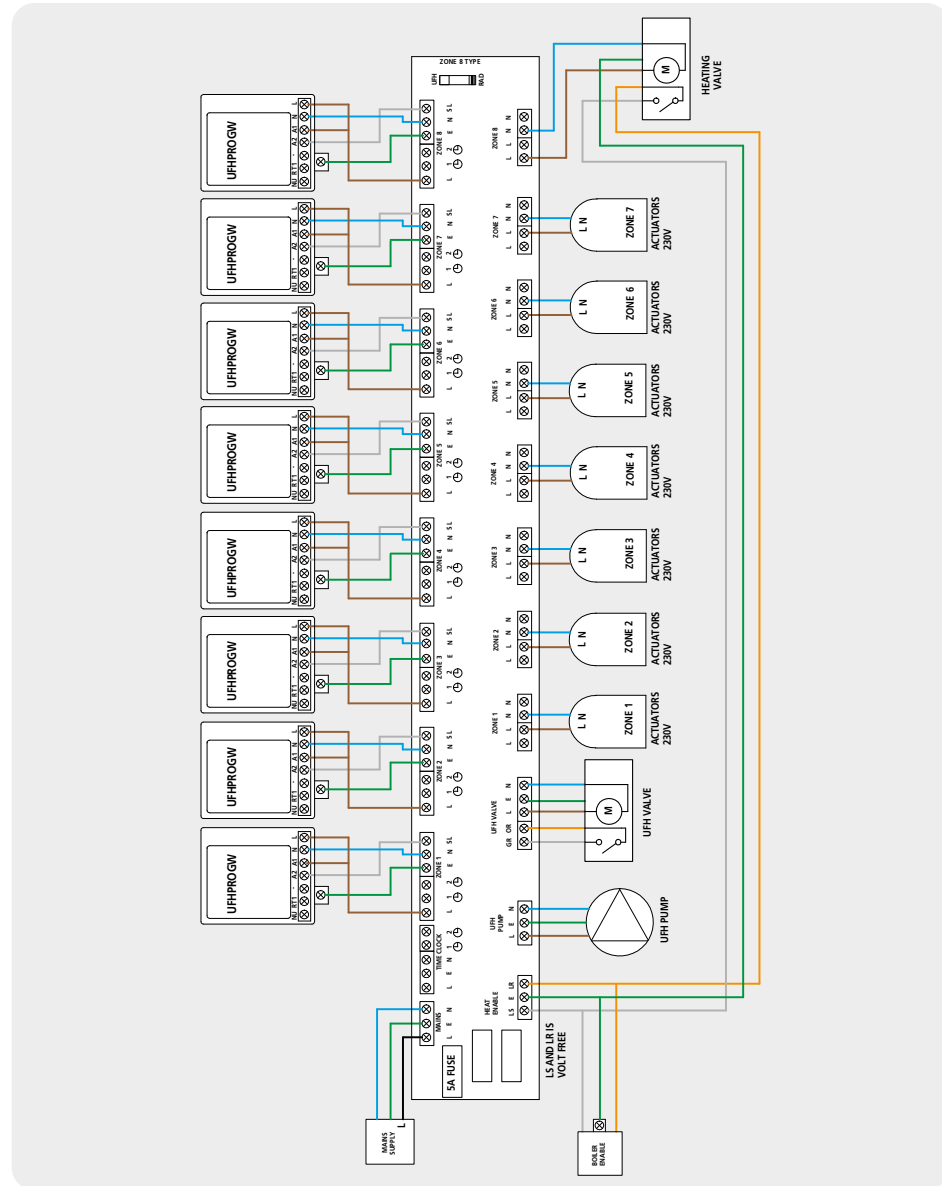

8 zone RF wiring centre (UFH8ZW)

Wiring detail for 4 underfloor heating zones (CH1) and 1 radiator zone (CH2) using UFHDIALW thermostats and UFHTIME4W timer.

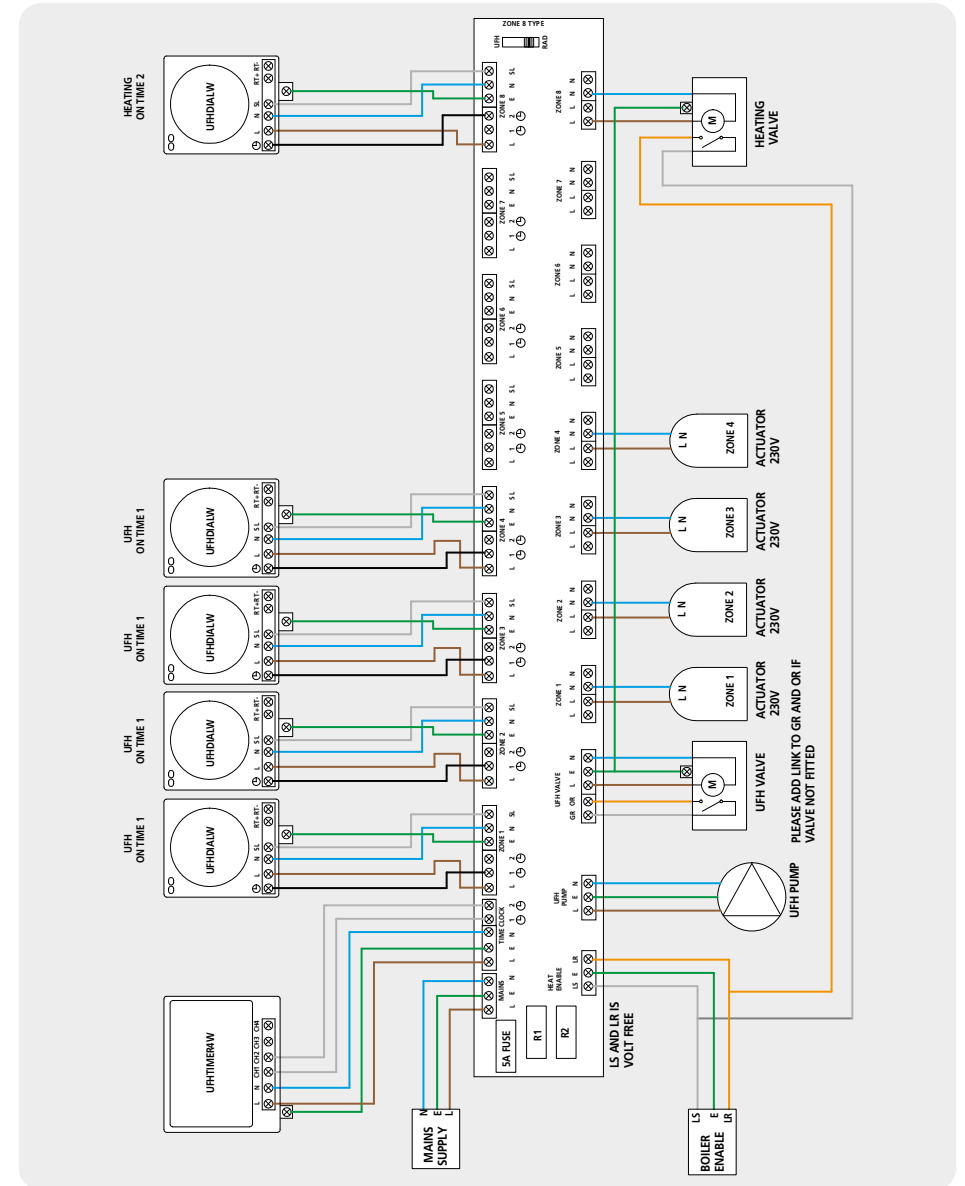

8 zone RF wiring centre (UFH8ZRFW)

Additional separate wiring detail for 1 DHW zone when using the UFH8ZRFW.

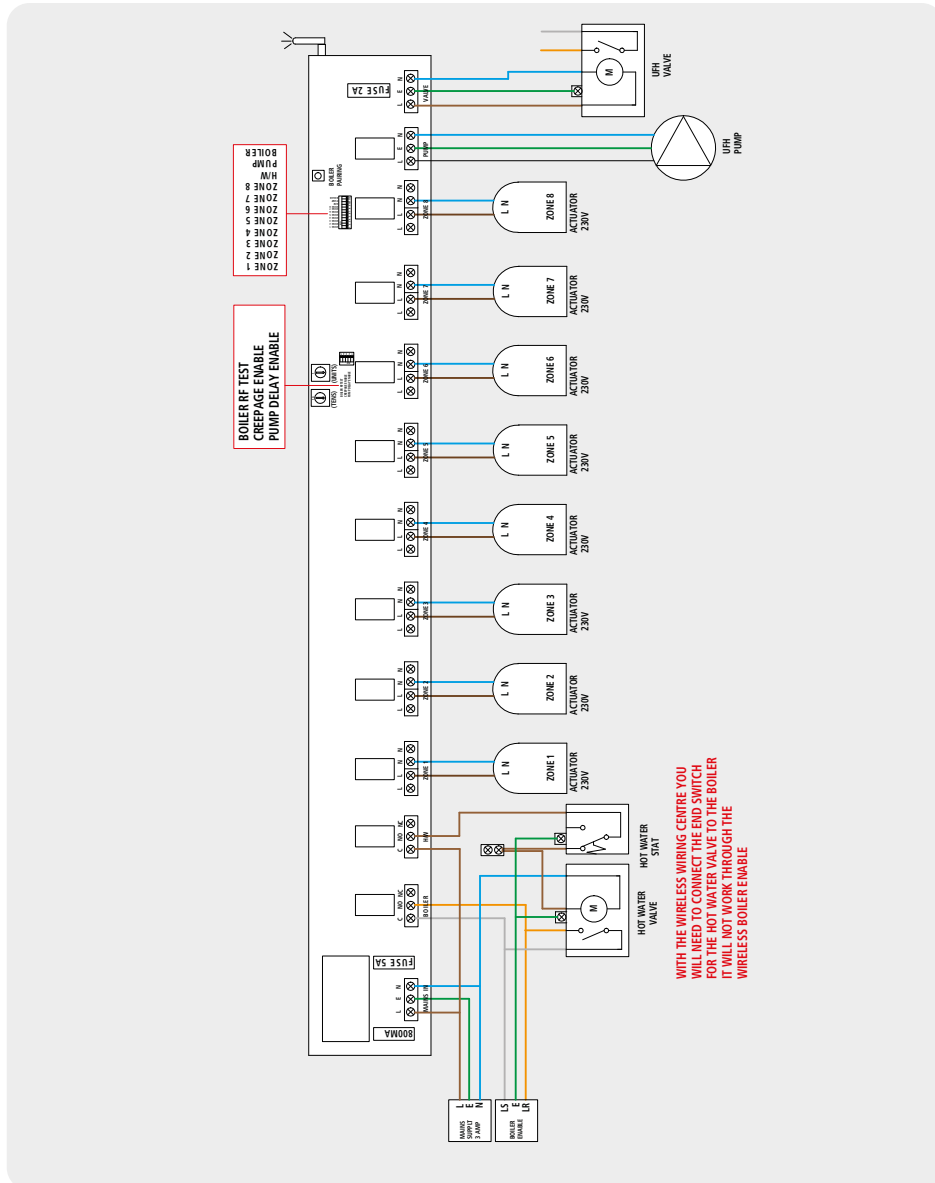

Pairing devices to the RF wiring centre (UFH8ZRFW)

First ensure that the wiring unit is correctly wired up to the electrical system in accordance with the instructions, as given in the installation manual supplied with the UFH8ZRFW.

Pairing RF Thermostats

On the UFH8ZRFW, take note of the numbers set on the rotary switches (UFH8ZRFW ID numbers 01-99).

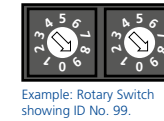

Each UFH8ZRFW on the system needs to have a different ID number.

- Use the Left / Right keys to scroll to < >.
- Press and hold the Tick key for 3 seconds ✓.
- SETUP will be highlighted, now press the tick key once ✓.
- The display will now show 01 in the top right hand corner.
- Press the Down key twice so that P2 shows on the display v .
- Press Tick once ✓.
- Use the Up/Down arrow keys to set the large digits to the board address of the UFH8ZRFW. This is the number set on the UFH8ZRFW rotary switches vΛ . (You must set a unique board address for each UFH8ZRFW installed).

- Press Tick once ✓. Small digits in the top right hand corner of the display will now flash.
- The UFH8ZRFW is an 8 zone receiver. Use the Up/Down keys to select the zone this thermostat should be linked to vΛ .
- Press Tick to select zone type (Underfloor Heating) ✓.
- Use the Up/Down keys to select UF = Underfloor Heating.
- Press tick to finish and confirm settings. Display will return to the main screen ✓.

System Setup

Step 1:

Each UFH8ZRFW board has 2 rotary switches labelled CHANNEL NUMBER, this number is used to identify the board and must be set to a unique number.

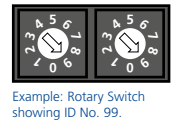

If you are only installing one UFH8ZRFW, you would normally set the channel number to 01. On the rotary switches this be 1 tens and 5 Units.

You can choose any numbers you wish up to 99 but no 2 units within radio range can have the same number.



Polypipe room temperature controls selection

All control options provide temperature control to each room as required, a summary of the options is shown below.

CONTROL TYPE	TIME CONTROL		DISPLAY/ OPERATION			CONNECTIVITY		
	PER ROOM	PER MANIFOLD	DIGITAL	DIAL	BUTTON	WIRED	WIRELESS RF	CONTROL VIA INTERNET
Simple Dial Wired Thermostats		☑		☑		☑		
Simple Dial RF Thermostats		☑		☑		☑		
Standard Programmable Wired Thermostats	☑		☑			☑		
Standard Programmable RF Thermostats	☑		☑				☑	

For Smart Plus controls, see pages 110–115.

Traditional Controls Range Room Thermostats

Standard Programmable Room Thermostats (UFHPROGB) and RF version (UFHPROGRFB)

Programmable room thermostats offer the following outstanding features:

- 7 day programming
- Setback and optimum start functionality
- Frost protection technology
- Holiday standby mode
- 9 preset programs for easy programming
- Simple user defined programming
- Wet room sensor connection



Time Clocks – 2 Zone Clock (UFHTIME2B) and 4 Zone Clock RF (UFHTIME4RFB)

The digital time clocks are used in conjunction with dial thermostats. The time clocks offer the following features:

- 7 day programming
- Frost protection technology
- Holiday standby mode
- 2 zone (2 manifold) control in the wired version (UFHTIME2B)
- 4 zone (4 manifold) control in the RF (UFHTIME4R FB) version
- 9 preset programs for easy programming
- Simple user defined programming



Simple Dial Room Thermostat (UFHDIALB) and RF version (UFHDIALRFB)

This simple dial type room thermostat combines accurate comfort control with a familiar dial type user operation.

This thermostat is used in conjunction with the time clock (PB2CTC or PB4CTC RF). All are provided with a wet room sensor connection.



Wiring centres

Single Zone Master Unit (PB1ZM) and RF version (PB2ZM RF)

The master wiring centres enable simple wiring and switching of all common components in the system.

For multiple zone systems this is used in conjunction with the slave units. Neon indicators show the status of the connections.

These wiring centres allow connection of:

- Heating main supply, UFH pump, zone valve and clock
- Both 230V and volt free boiler switching connection
- Connection for a single room thermostat (wired version) and 2 room thermostats in the RF version
- Plug in connectivity to the slave units for multiple zone control



Slave Units - 4 Zone Slave (PB4ZS and 6 Zone Slave PB6ZS) and 4 Zone RF version (PB4ZS RF)

These units are always used in conjunction with the wiring centre master unit and provide simple wiring of actuators and room thermostats for multiple zone control. Neon indicators show room activation.

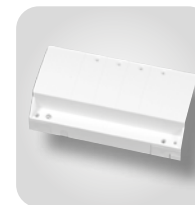

Ancillary items

Wet Room Sensors (PB23020)

Where temperature control needs to be provided to a bathroom or other wet area, this sensor is installed in the wet area and connected to any of the room thermostats which can be installed in an adjacent dry area.

The sensor is supplied with 3m of cable which can be extended to a maximum of 10m providing NTC 10k cable is used.

The sensor can be removed from the housing and used as a floor sensor where sensitive floor coverings are used.



Single RF Receiver (PBREC RF)

The receiver accepts a signal from any RF Thermostat or clock and allows RF clocks and RF stats to be used with wired master or slave units.



Wiring centres - for wired controls

Single Zone Master (PB1ZM)

When used in a 'single zone' application, the master wiring centre (Product Code: PB1ZM) provides the wiring connections for the underfloor heating pump, two-port zone valve, boiler switched live connection (230V or volt free) and the programmable room thermostat.

Wiring details for Single Zone Master Unit (PB1ZM)

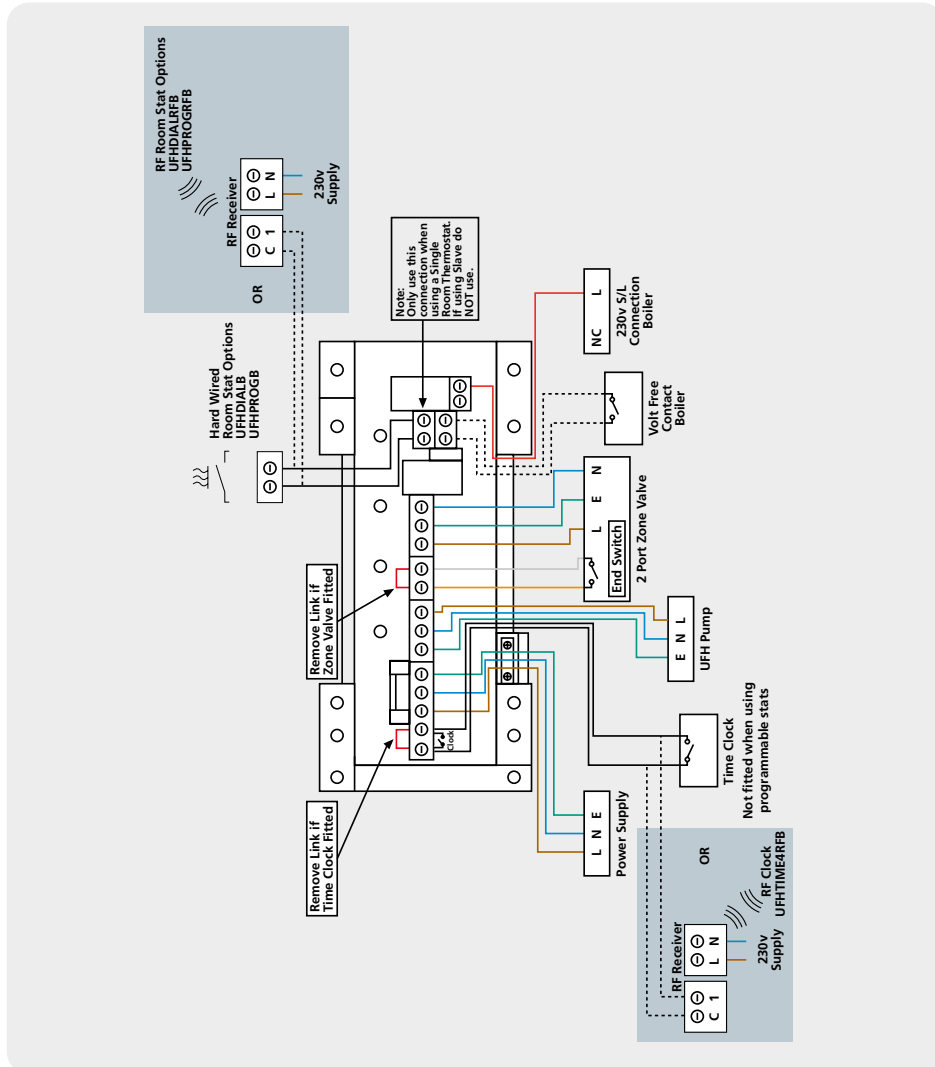

4 and 6 Zone Slave Unit (PB4ZS and PB6ZS)

Where multiple room controls are required, the master wiring centre should be used in conjunction with the 4 or 6 Zone Slave Units PB4ZS or PB6ZS. The slave units provide wiring connections for the programmable room thermostats and the manifold two-wire actuators. Up to four actuators can be connected per zone. The 4 and 6 zone slave units (PB4ZS and PB6ZS) must be used in conjunction with the Single Zone Master (PB1ZM). The slave unit simply plugs into the master unit to provide additional connections for the required number of control zones.

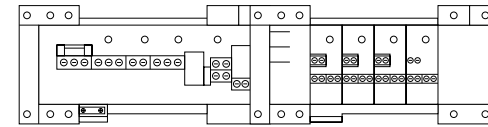

Wiring details for 4 and 6 Zone Slave Unit (PB4ZS and PB6ZS)

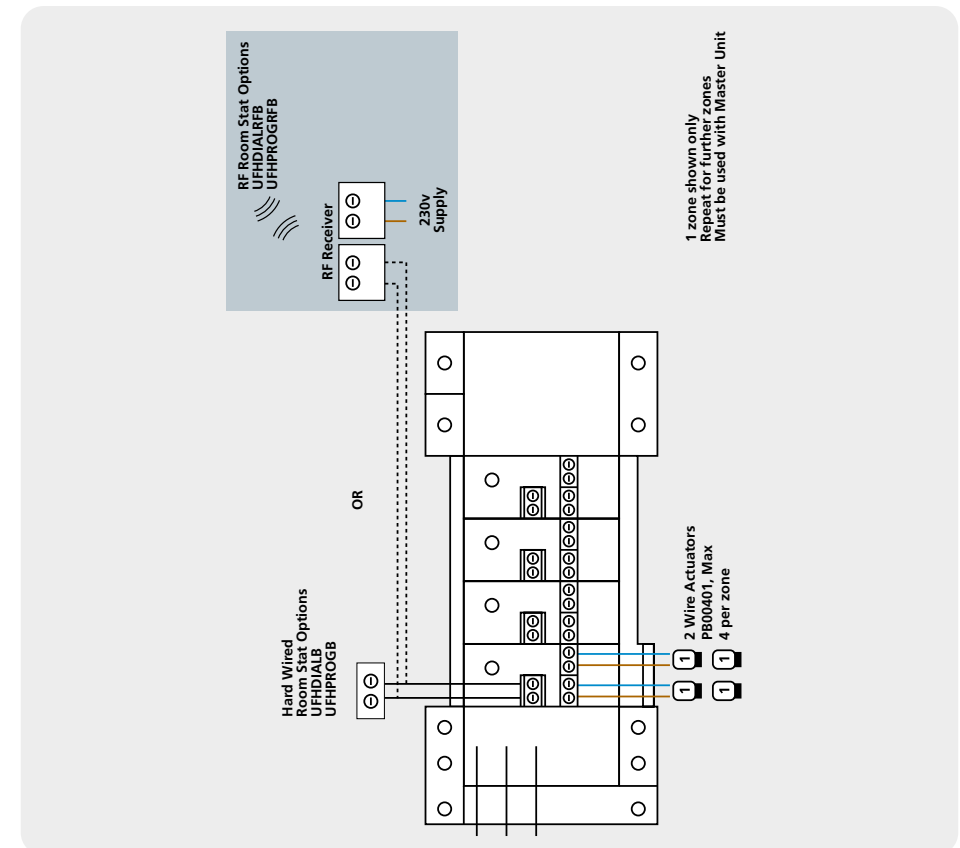

Wiring centres - for RF controls

2 Zone Master Unit RF (PB2ZM RF)

The PB2ZM RF master unit provides electrical connections for the underfloor heating pump, motorised valve, actuators, boiler and up to two control zones.

Wiring details for 2 Zone Master Unit RF (PB2ZM RF)

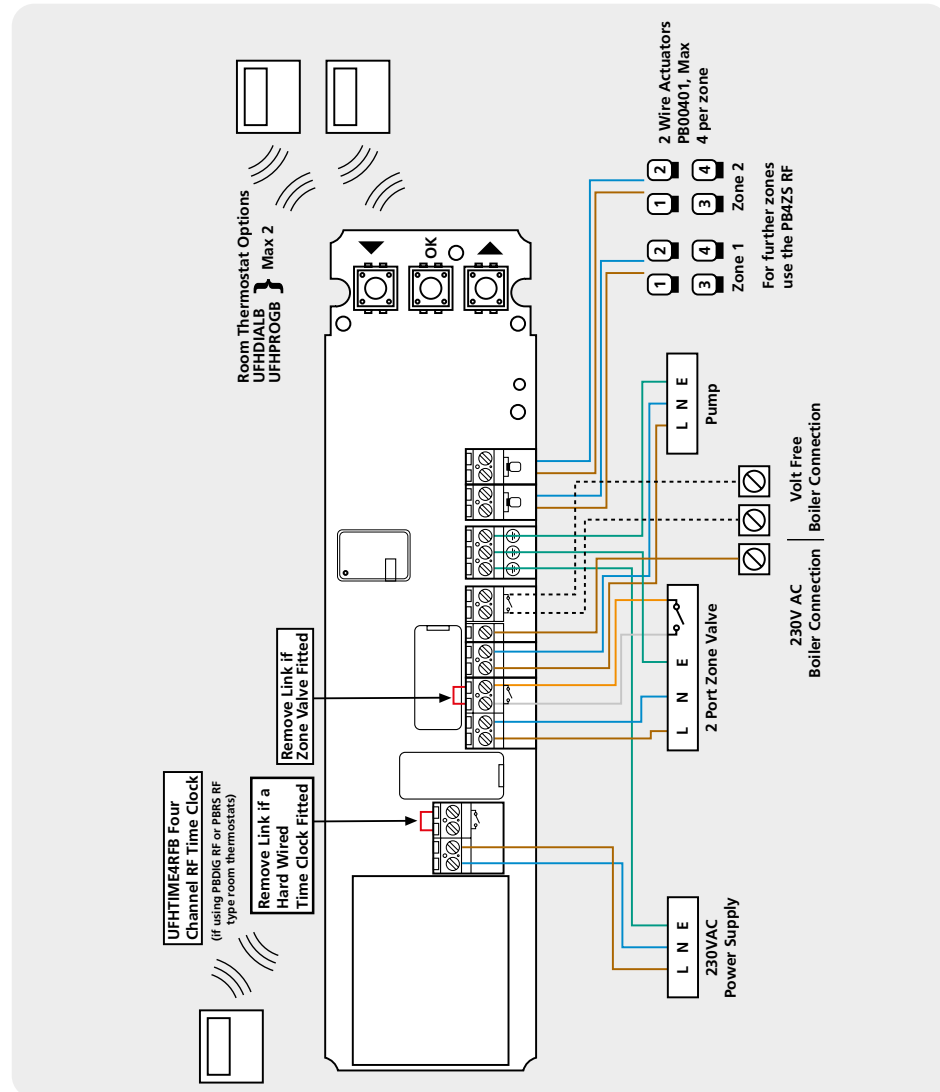

4 Zone Slave Unit RF (PB4ZS RF)

Where more than two zones of control are required, the PB4ZS RF is used with the PB2ZM RF master unit to provide up to four additional control zones. The unit provides wiring for up to four actuators per zone and four built-in zone receivers.

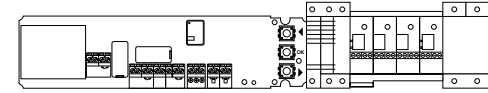

Wiring details for 4 Zone Slave Unit RF (PB4ZS RF)

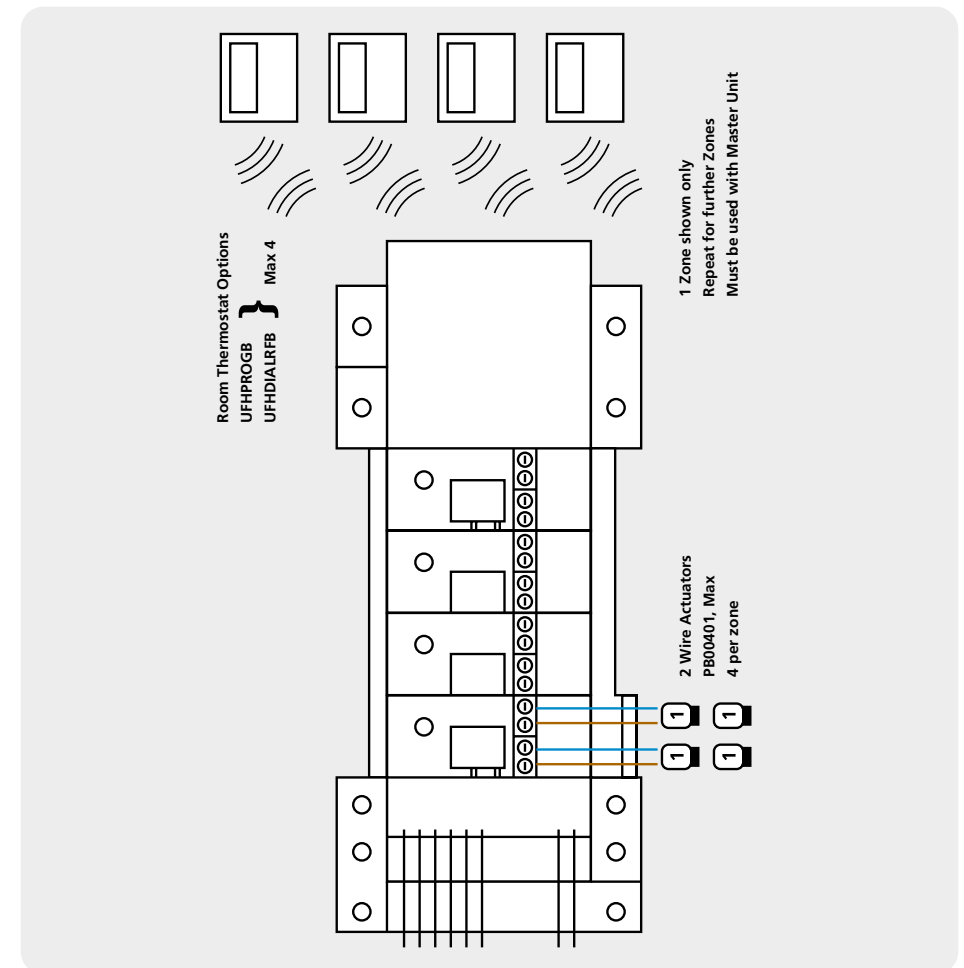

Pairing devices to the master and slave unit

First ensure that the wiring unit is correctly wired up to the electrical system in accordance with the instructions, as given in the installation manual supplied with the PB2ZM RF. Switch on the power to the unit and the green power LED should illuminate. Important – please ensure that all RF devices are switched off before and after pairing to ensure they do not interfere with the pairing of other devices.

Pairing RF Thermostats (UFHPROGRFB and UFHDIALRFB)

Step 1:

Press and hold the OK button for approximately 10 seconds and the first green LED will flash green.

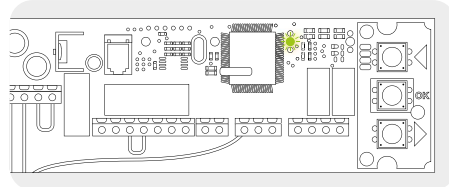

Step 2:

Press the OK button again quickly and the first LED will turn red to show that the first zone is ready to be paired with the relevant room thermostat. At the same time the second LED will flash green.

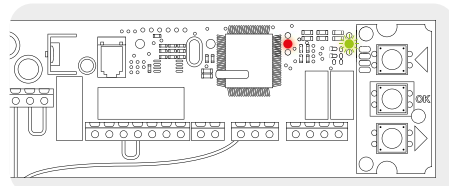

Step 3:

To pair the UFHPROGRFB thermostats you will need to put the unit into pairing mode by accessing the user menu. To do this you will need to put the unit into Auto mode and press and hold the OK button for 5 seconds. The unit should display "RF INIT".

To pair the UFHDIALRFB, move the slider from the "Off" position to the "On" position.

The green LED will flash for 10 seconds to indicate that the unit is trying to establish communication with the RF receiver unit.

The LED will flash green to indicate that the unit is trying to establish communication with the RF receiver. Once the signal is accepted the LED on the wiring unit will turn solid green. If pairing several thermostats remember to return the slider to the 'Off' position before pairing an additional unit.

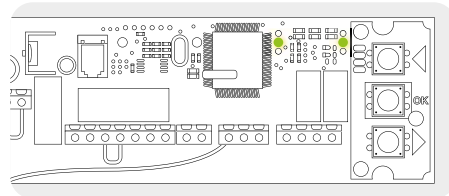

Step 4:

Press the OK button again quickly and the second LED will now flash red indicating that the second zone is ready to be paired. Follow the same pairing process for this zone outlined in the previous steps.

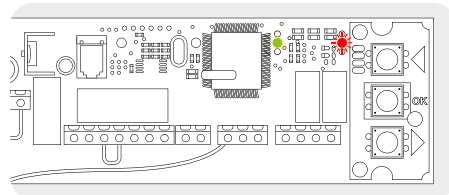

At this stage the PB2ZM RF wiring unit will now be paired to the two thermostatic zones. If an additional RF Slave Unit is to be used continue to follow the above procedure until all of the remaining zones have also been paired.

Additional Information

To toggle between zones to be paired use the left and right arrow buttons.

IMPORTANT NOTE:

At this stage the thermostat units will now be paired to their relevant master wiring centre and slave unit zones (if used). In the case of the UFHPROGRFB fully programmable units, where no additional timer unit is to be used, it is necessary to now complete the pairing process by pressing and holding the OK button until all of the LEDs go out. Once this happens the pairing process is now complete and the zones should respond to the relevant demand signals from thermostat unit(s).

Step 5: Pairing the Time Clock

Where the UFHDIALRFB unit has been used, it is necessary to now pair the relevant timer channel on the UFHTIME4RFB time clock to the master wiring centre. To do this you will need to access the Installer Menu in the time clock by following the instructions supplied with the unit. Once you have chosen the required channel and have initialised the pairing function, all of the green LEDs will switch off inside the master unit and slave unit to indicate that the pairing of the time clock has been successful.

Please note that no actions are necessary to the master wiring centre.

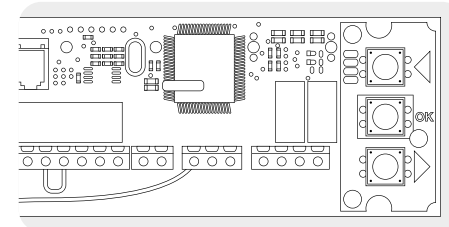

Once the time clock and room thermostats have been switched to the required operating mode the system will respond accordingly.

Performing a full factory reset

Sometimes it may become necessary to return the master wiring unit and slave unit (if fitted) to their factory resets. This action will completely erase any current pairing information and enable the units to be fully reprogrammed.

Depending on whether the RF master unit is in 'programming mode' or 'auto mode' please follow the instructions below.

Unit in programming mode

In order to perform a full factory reset whilst the master unit is already in the programming mode, you will first need to hold down all three buttons simultaneously until both of the green LEDs illuminate. Continue to hold down these buttons until the green LEDs go out. When this happens release the buttons. The green LEDs will flash once and then go out. The unit is now returned to full factory reset mode.

Unit in auto mode

If the unit is already in normal operation mode, in order to perform a full reset of the unit you will first need to switch the unit in to its 'programming mode'. To do this, first press and hold the OK button until the first green LED illuminates. Then quickly press the OK again until the first LED turns red. The unit is now in 'programming mode'.

Next, hold down all three buttons simultaneously until both of the green LEDs illuminate. Continue to hold down these buttons until the green LEDs go out. When this happens release the buttons. The green LEDs will flash once and then go out. The unit is now returned to full factory reset mode.

Single Room Applications

The Polypipe Zonal Regulation Unit (ZRU) allows single rooms and extensions up to 30m² to be connected to an existing heating system, without time consuming and expensive hydraulic and electrical alterations.

When connected to an existing radiator heating system, the ZRU converts the water flow and temperature to that suitable for underfloor heating.

- Water is thermostatically blended to provide the ideal safe flow temperature control
- A sensor within the unit ensures operation will only occur when the flow temperature reaches 45°
- The room thermostat (if fitted) regulates air temperature in the space being heated by stopping the pump as built into the ZRU
- The ZRU can be positioned elsewhere within the property within close proximity to the room to be heated and the existing heating pipe work.
- The ZRU can be used in both domestic and commercial buildings
- As the ZRU thermostatically controls water temperature, the unit can also be used where low surface temperature heating by radiators is required



Pipe connections at ZRU

Provision for two heating circuits is provided on the ZRU. If only one circuit is required, blank off the unused ports with spigot blanking plugs.

Elbows should be used underneath the ZRU to exit pipe from the floor and a small section of floor plate should be cut away to allow the pipes to exit the floor at the correct position.

These elbows should be covered with polystyrene, prior to and during screeding, to allow for future excavation if required. Alternatively, they can be enclosed within a PolyPlumb Junction Box.

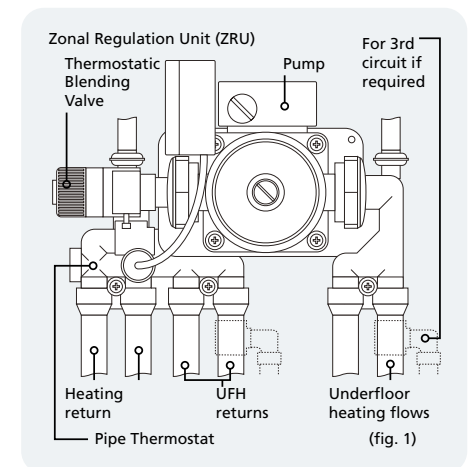

Connections to the existing wet heating system

The pipework connections to the ZRU are for 15mm diameter pipe and the ZRU should not be connected to the system from any pipe smaller than 15mm.

A small number of boilers can be affected hydraulically by the use of a second pump in the system.

NOTE:

Check with the boiler manufacturer to ensure compatibility with the ZRU.

The preferred connection to the ZRU is to the main flow and return pipework of a 2 pipe system, i.e. typically from 22mm distribution pipework. However, it can also be connected to the nearest existing radiator.

Pipe connection to operate underfloor heating at the same time as the boiler

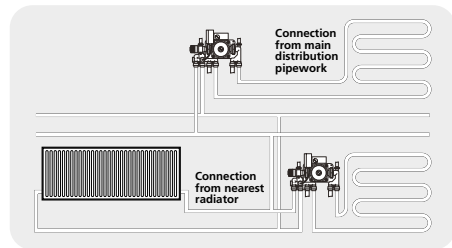

The diagram above shows the ZRU connected to operate with the boiler on/off firing. Due to the quick response of low mass systems (Overlay™, Overlay™ Lite, MHP, etc.) this is likely to be suitable. Using this method for solid floor installations may require the timings of the existing heating to be altered to allow the underfloor heating system to reach comfort temperature.

If the room is to be controlled independently of the existing central heating system, a zone valve needs to be installed between the boiler and the ZRU.

Pipe connection to operate ZRU/underfloor heating independently

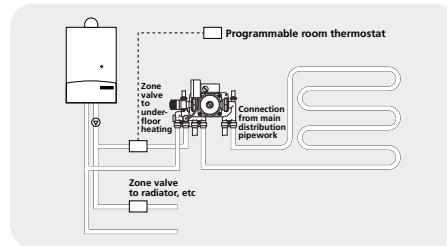

Operational sequence

Step 1:

Heating water from the existing system is pumped through the heating flow by the existing heating pump and returns through the heating return forming a simple loop.

Step 2:

The pipe thermostat senses that heating water is available i.e. when the main heating system is on and sends a live signal to the pump.

NOTE:

The water temperature must be 45°C to operate the unit.

Step 3:

If a room thermostat is fitted that must also be calling for heat demand before the ZRU will operate.

Step 4:

A mixture of heating flow and underfloor heating return water is drawn through the thermostatic blending valve at the correct temperature and pumped into the underfloor heating.

Step 5:

As the room reaches temperature, the room thermostat will break the live signal to the pump and stop the pump from operating.

Step 6:

As the boiler shuts down and the main heating flow cools, the pipe stat will break the live signal to the pump and stop the pump from operating.

Performance and safety data info

1. Maximum ambient air temperature is 60°C at 95°C fluid temperature.
2. Pressure rating is PN6.

Room kits

A range of room kits containing all flooring and ZRU are available			
Type	Solid Floor	Overlay™	Overlay™ Lite
Area	12m ² (So12Z)	12m ² (O12Z)	12m ² (OL12Z)
	20m ² (So20Z)	20m ² (O20Z)	20m ² (OL20Z)
	30m ² (So30Z)	30m ² (O30Z)	30m ² (OL30Z)

A 5m² Overlay™ Bathroom Kit (O5B) is controlled with a temperature limiting valve rather than the ZRU

Installation of ZRU

The ZRU can be positioned either in the room where the underfloor heating is installed or in an adjacent area, 100mm from the finished floor level to allow for pipe connections. Tape fixing template to wall showing fixing positions and drill wall and fix plugs.

Fitting the ZRU

Step 1:
Screw unit to wall.

Connecting the ZRU

Step 2:
Connect heating pipework via an isolation valve.

Step 3:
Connect underfloor heating circuit(s) using an isolation valve. Use tees and spigot elbows to form connections for 3rd circuit systems.

Step 4:
Connect mains wiring (as diagram opposite) via a fused spur.

Filling (all systems)

The pipe system should be filled, usually by means of a hosepipe, prior to screeding or floor covering if the ZRU is to be installed at a later time than the underfloor circuit. E.g. to allow for plastering, etc. Pipework should be temporarily capped and remain full of water, preferably at pressure. Special precautions are necessary if the pressure testing is to take place in sub-zero temperatures.

Wiring details

All electrical installations must be in accordance with the latest version of the relevant building regulations. The ZRU must be installed in a way that allows it to be disconnected from the mains supply and a contact separation must be incorporated in all poles that provide full disconnection under overvoltage category III.

The means for disconnection must be incorporated in the fixed wiring in accordance with the wiring rules. If in doubt, contact a qualified electrician. The wiring diagram is as shown.

NOTE:

The water temperature must be 45°C to operate the unit.

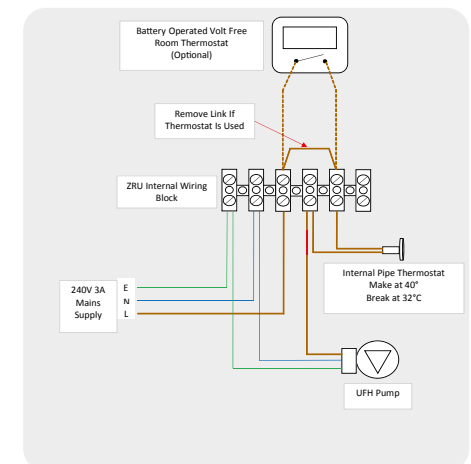

Underfloor Heating Room Kits

The simplest way to enjoy affordable luxury heating in your bathroom, kitchen, bedrooms or living spaces.



Live in the comfort of your own home

Polypipe
Underfloor Heating

Hydraulic fault finding chart

Before using this flow chart please ensure that both the primary and underfloor heating systems are full and that all isolating valves are fully open. Please also ensure that the room thermostats are calling for heat.

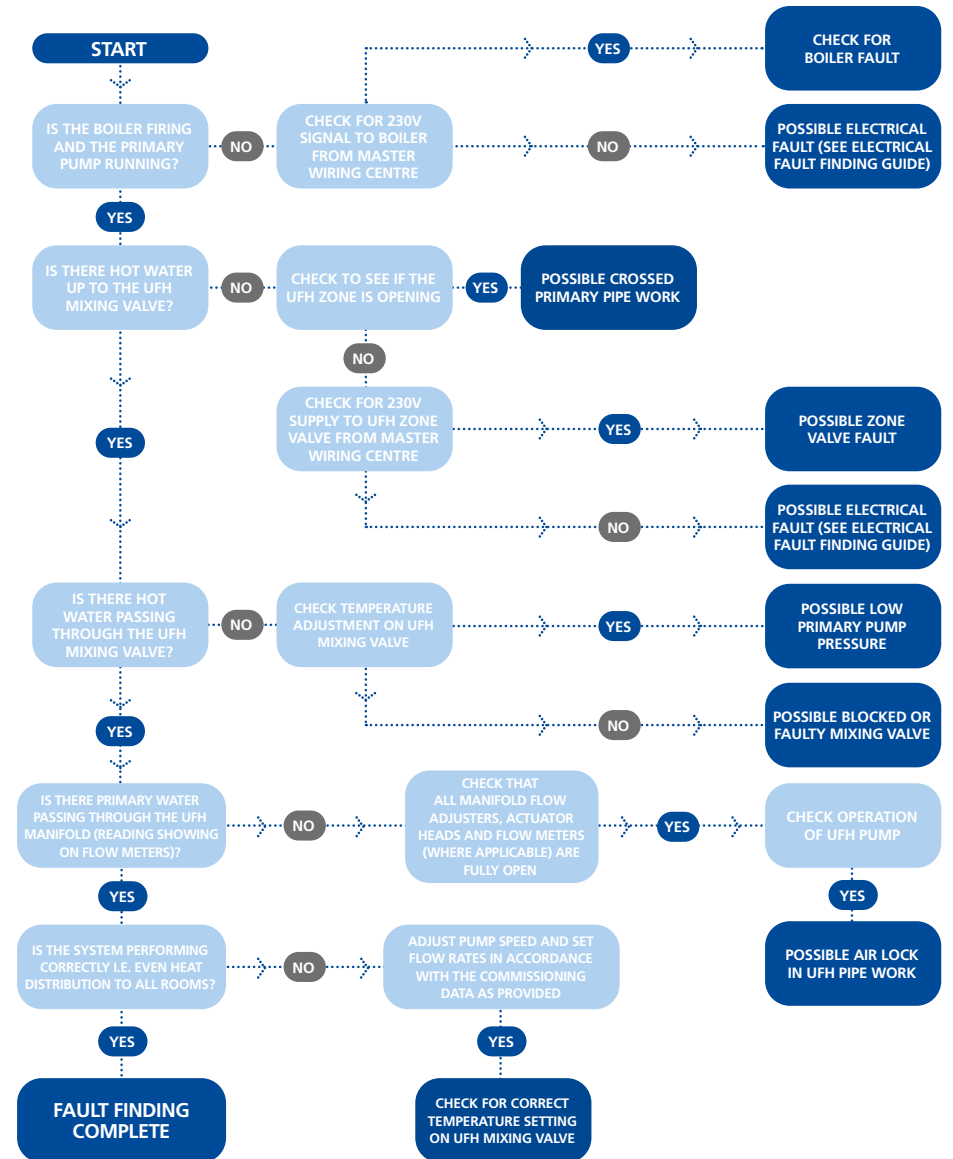

Electrical fault finding chart (master connecting box)

This testing procedure should only be carried out by fully qualified persons. Testing should be done with all switches on and room thermostats calling.

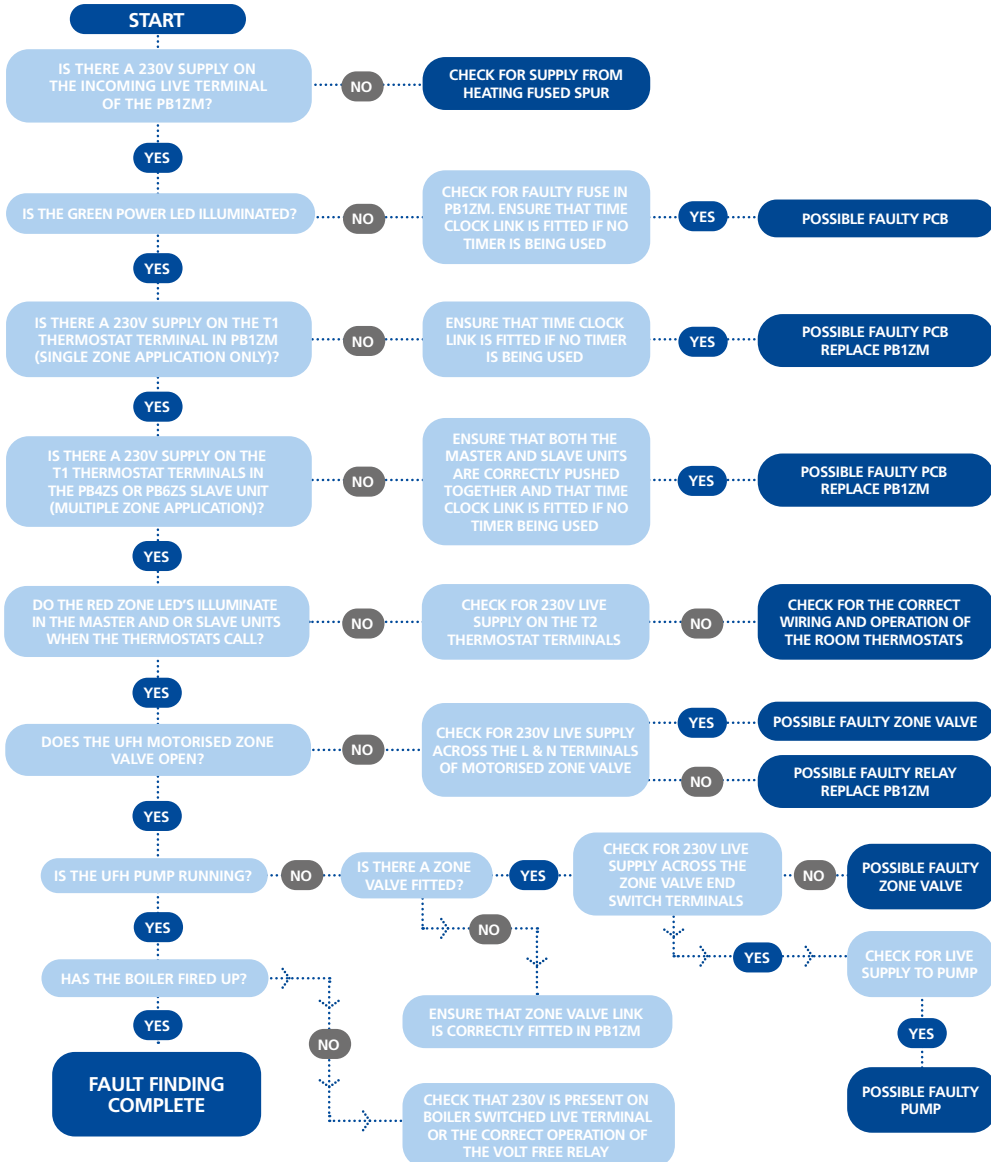

Standards & Approvals

Standards and Polypipe guarantee information

Polypipe meets, and constantly strives to exceed, the changing laws and regulations governing our operations and products. We have invested in extensive testing and development facilities to ensure the products we supply are of the highest quality. Our plumbing systems conform to a number of third party accredited standards, which are listed below.

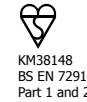

British Standard Class 5 rated to BS7291 Part 1 and Kitemark Licence Number 38148 to BS7291 Part 1 and 2.



PolyPlumb polybutylene barrier pipe, fittings and accessories are covered by BBA Certificate No. 00/3699.



Listed in the WRAS Water Fittings and Materials Directory.



Standards Manufacturing Quality Assurance in accordance with BS EN ISO 9001 (BSI registered firm Certificate FM00318).



British Gas has accepted the Polypipe 'PolyPlumb' and 'PolyFit' Class 5 polybutylene pipe systems as being acceptable for open vented and sealed central heating systems and are eligible for acceptance onto Home Care Central Heating System Cover.

- Installation Standard – to follow the requirements of BS5955 – PART 8 2001 Plastic pipework (Thermoplastic Materials) (PolyPlumb/PolyFit/PolyMax/PolySure)
- BBA – PolyPlumb polybutylene barrier pipe, fittings and accessories are covered by BBA Certificate No. 00/3699 (PolyPlumb)
- AENOR – The Spanish Association for Standardisation and Certification (PolyPlumb)

All installation practices must be observed. See this guide and our website www.polypipe.com for more information

At Polypipe we pride ourselves on offering the highest quality products and wherever possible our products and processes are covered by independent third party accreditation, so you can rest easy knowing that you are buying from the UK's market leading manufacturer. We have invested significantly in our quality control procedures, have our own fully-equipped modern laboratory for development and analysis and also have our own tooling and extrusion processes.

Guarantee

Polypipe guarantees for 25 years against defects in materials or manufacture of the PolyPlumb, PolyMax and PolyFit hot and cold water supply and heating systems from date purchased. We also guarantee 50 years for underfloor heating pipe and all other underfloor heating component parts (including manifolds, controls and accessories) have a 2 year guarantee.

This guarantee only applies if the products are installed in accordance with the manufacturer's recommendations and are used in a normal domestic operation.

A normal domestic operation is defined as a residential property and excludes commercially run residential properties e.g. care homes. It is also defined as being part of an open vented or sealed central heating system, direct or indirect single pipe hot water supply, or mains or tank fed cold water supply system.

The system must be designed, installed and operated within the temperature and pressure ratings as defined in BS 7291 Class S, which are also published in the manufacturer's literature and must also take account of all the other exclusions and limitations as defined in the design, application and installation guidance provided by the manufacturer.

Certain fittings in the PolyPlumb, PolyMax and PolyFit ranges are not suitable for all Class S service conditions. The limitations are indicated against every applicable fitting in the Trade Price List e.g. 'Cold Water Only'.

For Polypipe's Contract of Sale, please refer to www.polypipe.com

Pre-insulated pipe

Pre-insulated piping systems are now available from Polypipe Building Products. This new product range includes a double flexible pre-insulated, self-compensating underground pipe, along with all fittings and coupling necessary for an easy installation.

Our pre-insulated pipes are suitable for 'single plot' applications such as remote boilers and heat pumps.

Available Standard coil lengths available 'off the shelf'

Flexible Quick and easy to install with flow and return in one lay

Durable Inner PEX barrier pipe and corrugated HDPE outer casing

Reliable Brass mechanical clamp fittings require no special tools

Ask your local Polypipe representative for more information and literature. The Product Guide and Price List (PIPPG5) can also be downloaded from www.polypipe.com

Further Technical Information

Technical support

We offer a full range of product installation information both on and offline, including:

- Underfloor heating quotation tool and product selectors
- Price lists and product guides
- Underfloor heating design service
- Installation videos

For technical support contact our Technical Services Department on **01709 772200**



Registered Heating Engineer

Polypipe has a well established network of registered underfloor heating installers. Become a member and benefit from:

- BPEC training and accreditation at our state-of-the-art Professional Development Centre*
- Qualified leads in your area
- Dedicated web page for your business
- Full marketing support
- Professional branded workwear
- Support from your dedicated Heating Manager
- Priority help desk technical support
- Priority quote turnaround
- Access to the widest range of heating and controls on the market
- Credibility from the UK's leading plastic plumbing manufacturer

Find out more and apply at www.polypipeuh.com/professional



Polypipe provides a range of technical support both printed and online. Go to www.polypipeuh.com to download literature and access our online tools.

Plumbing & Heating Installation Guide

Polypipe Ulster

Dromore Road, Lurgan Craigavon,
Co. Armagh BT66 7HL, UK

T: +44 (0) 28 38 881270

F: +44 (0) 28 38 882344

Polypipe Building Products

2410 London Road, Mount Vernon,
Glasgow G32 8XZ, UK

T: +44 (0) 141 778 8822

F: +44 (0) 141 778 2703

Polypipe Building Products

Broomhouse Lane, Edlington,
Doncaster DN12 1ES, UK

T: +44 (0) 1709 770000

F: +44 (0) 1709 770001



Find us on 

www.facebook.com/polypipetrade



www.instagram.com/polypipetrade



www.twitter.com/polypipetrade